

ER-51XX

SAMSUNG

ELECTRONIC CASH REGISTER

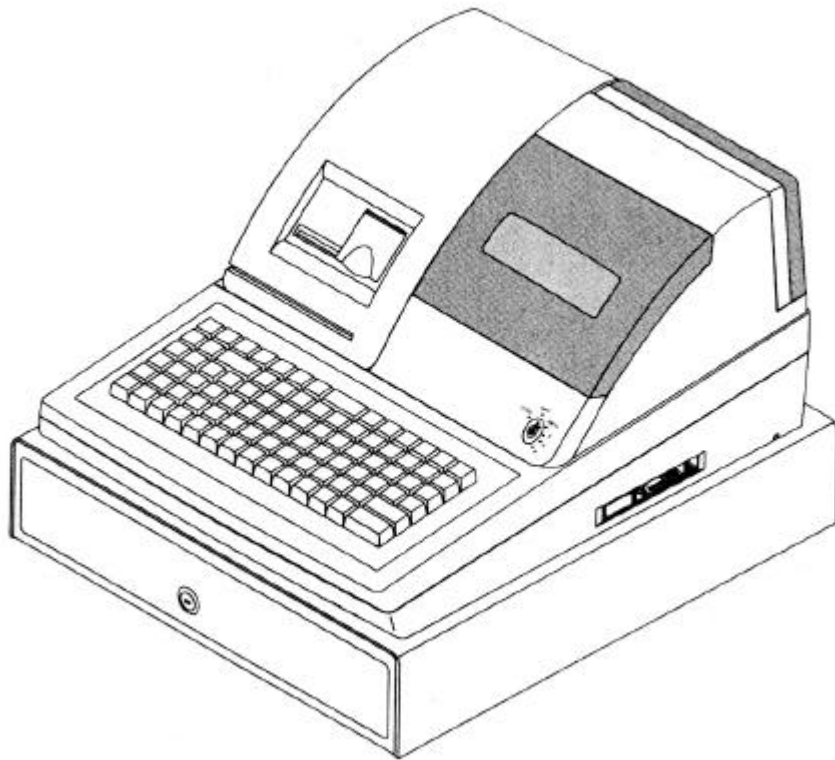

Programming & Operating Manual

WITH EURO CONVERSION OPTIONS

All specifications are subject to change without notice.

UNPACKING AND STARTING UP

STEP 1 UNPACKING THE CASH REGISTER

- (1) **Unpack and unwrap** your cash register.
- (2) The following items are **in the packing**.
 - **2 paper rolls**
 - **1 rewind spindle**
 - **1 ribbon cartridge**
- (3) **Remove cardboard protectors from the cash drawer.**

STEP 2 INSERTING THE PRINTER RIBBON CARTRIDGE

- (1) Locate the **printer cover key**. The printer cover key is **the smallest** on the key ring.
Insert this key into the **printer cover lock**. **Turn the key** and then **remove the printer cover**.
- (2) Locate the **ribbon cartridge** as shown in the illustration.
- (3) **Insert the ribbon cartridge** and press firmly into the place.
Remove any slack in the ribbon by rotating the cartridge knob counter-clockwise.

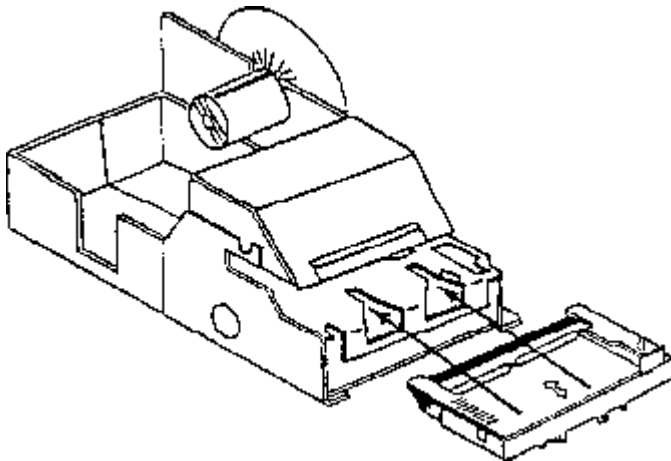

STEP 3 PUTTING THE PAPER IN THE PRINTER

STEP 3.1 LOADING THE DETAIL PRINTER

- (1) **Plug** the cash register's power cord into the properly grounded wall socket.
- (2) Place the **key marked ' REG' into the control lock and turn to the " REG" position.**
- (3) Locate the **black plastic rewind spindle** in the Styrofoam.
- (4) As you face the keyboard, **notice two plastic trays** at the bottom of the printer compartment.
Place one of the paper rolls into the tray on the right.
Make sure the paper will unwind from the bottom of the roll.
- (5) **Fold back about 6 inches of paper and insert the folded end of the tape** into the feed slot just in front of the paper tray at the rear of the printer.
- (6) **Press** the " **DETAIL FEED**" key on the keyboard until the edge has fed through the printer.
Run 6 ~ 8 inches of paper through the printer.
- (7) **Hold the black rewind spindle** with the gear to the right and the shaft to the left.
Insert the end of the paper into the slot on the shaft of the rewind spindle.
Wind the spindle several times to be sure that the paper will stay on the spindle.
- (8) **Slide the axle of the rewind spindle** (between the gear and the shaft) into the notch of the printer housing.
- (9) **Press** the " **DETAIL FEED**" key several times again to make sure that the paper moves properly through the printer.

NOTE : The socket-outlet shall be near the equipment and it shall be easy accessible.

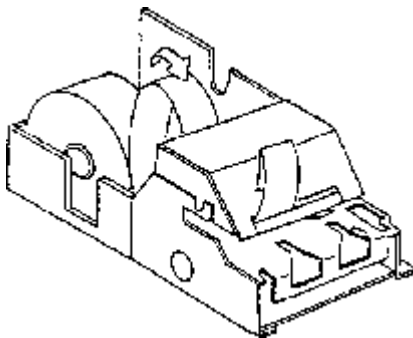

* LOADING DETAIL PAPER *

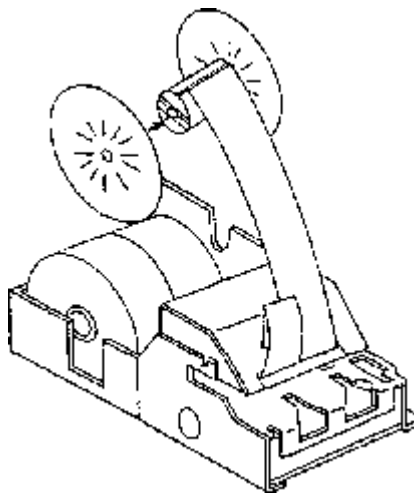

* LOADING RECEIPT PAPER *

< THE FABRICATION OF REWIND SPINDLE >

- (1) Locate the black plastic rewind spindle (A) in the Styrofoam.
- (2) Locate the black plastic rewind spindle (B) in the manual bag.
- (3) Fabricate the black plastic rewind spindle (A) and (B) as shown in the illustration.

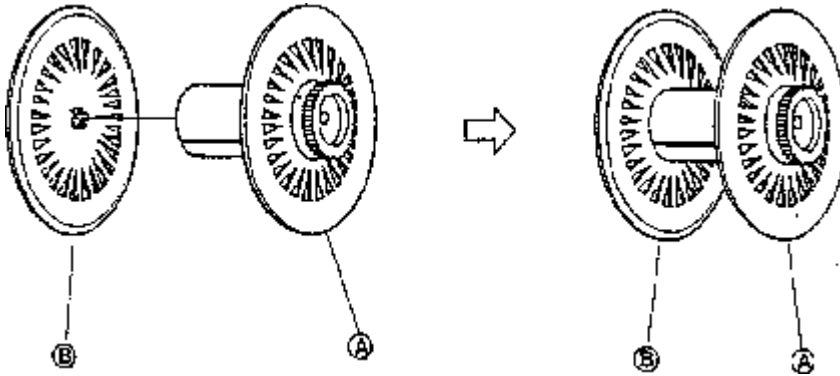

STEP 3.2 LOADING THE RECEIPT PRINTER

- (1) **Place the other paper rolls** into the small tray on the left.
Make sure the paper will unwind from the bottom of the roll.
- (2) **Fold back about 6 inches of paper** and **insert the folded end of the tape** into the feed slot just in front of the paper tray at the rear of the printer.
- (3) **Press the " RECEIPT FEED" key** on the keyboard until the paper comes through the printer.
Run 3 ~ 4 inches of paper through the printer.
- (4) **Replace the printer cover** and make sure that **the receipt paper comes out through the opening** in the printer cover.

NOTE : Do not pull the paper back through the printer as this may damage it.

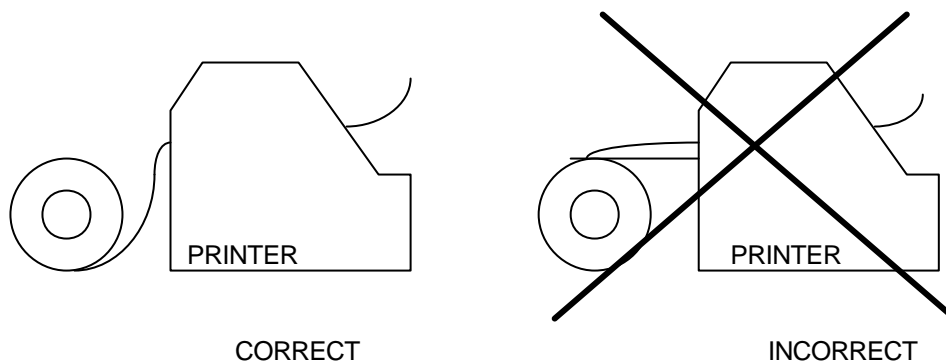

STEP 4 CLEARING THE RAM (RANDOM ACCESS MEMORY)

- (1) **Unplug** the cash register.
- (2) Locate the **control lock key** marked ' C' .
- (3) **Insert the key** into the control lock and **turn clockwise**, past the " P" position to the " **SERVICE MODE**" position.

This position is not marked on the control lock, but the 'C' key can travel to this position.

- (4) **Hold down** the " 00" key on the keyboard.

While holding the " 00" key **down**, **plug** the cash register's **power cord** into properly grounded wall socket.

Continue to hold the " 00" key down until the receipt printer stops printing and the display shows 0.00.

!! The cash register is now ready to operate. !!

WARNING : Clearing the RAM is essential before you program the cash register for the first time.
However once the cash register is programmed and operated,
clearing the RAM will cause all programs and totals to be lost.

WARNING : Do not open the printer cover while operating the cash register.
Do not operate the cash register without the ribbon cartridge.

NOTE : When you firstly configure the cash register, it is recommended that the register remains powered on in the " REG" mode for at least 24 hours.
This allows the Ni-Cad battery, which maintains the memory of the machine while the power is off, to charge completely.

TABLE OF CONTENTS

UNPACKING AND STARTING UP	1
FEATURES	9
KEYBOARD LAYOUT	10
1 ER-5115 KEYBOARD LAYOUT	10
2 ER-5140 KEYBOARD LAYOUT	11
FUNCTION KEY DESCRIPTION	12
CONTROL LOCK	14
CONTROL KEYS	14
DISPLAY	15
DISPLAY SYMBOLS	15
PROGRAMMING NOTE	17
1 SERVICE MODE PROGRAMMING	17
1.1 RAM CLEARING	17
1.1.1 INITIAL CLEAR	17
1.1.2 CLEARING TOTALS FROM MEMORY	18
1.2 SETTING THE NUMBER OF DEPARTMENTS	19
2 P MODE PROGRAMMING	20
2.1 DATE & TIME PROGRAMMING	20
2.1.1 DATE PROGRAMMING	20
2.1.2 TIME PROGRAMMING	20
2.2 REGISTER NUMBER PROGRAMMING	20
2.3 TAX PROGRAMMING	21
2.4 VAT RATE PROGRAMMING	21
2.5 CLERK SECRET CODE & DRAWER ASSIGNMENT PROGRAMMING	22
2.6 SYSTEM OPTION PROGRAMMING	23
2.7 DESCRIPTOR PROGRAMMING	29
2.7.1 PROGRAMMING	29
2.7.2 DESCRIPTOR PROGRAMMING EXAMPLES	30
2.7.3 DESCRIPTOR PROGRAMMING SCAN	31
2.8 DEPARTMENT PROGRAMMING	32
2.8.1 DEPARTMENT STATUS PROGRAMMING	33
2.8.2 DEPARTMENT PRICE OR HALO PROGRAMMING	33
2.8.3 DEPARTMENT PROGRAMMING EXAMPLES	35
2.8.4 DEPARTMENT PROGRAMMING SCAN	36
2.9 PLU PROGRAMMING	37
2.9.1 PLU PROGRAMMING	38

2.9.2 PLU PROGRAMMING EXAMPLES	39
2.9.3 PLU PROGRAMMING SCAN	40
2.9.4 PLU LINK PROGRAMMING	41
2.9.5 REMOVING OR DELETING A PLU	41
2.10 % KEY PROGRAMMING	42
2.10.1 % KEY PROGRAMMING	42
2.10.2 % CALCULATION ROUNDING FACTOR	42
2.11 CASH/TEND KEY PROGRAMMING	43
2.12 CHEQUE KEY PROGRAMMING	43
2.13 CHARGE KEY PROGRAMMING	43
2.14 PRESET CASH KEY PROGRAMMING	43
2.15 CASH IN DRAWER LIMIT PROGRAMMING	43
2.16 CURRENCY CONVERSION KEY PROGRAMMING	44
2.17 EUROPEAN ROUNDING PROGRAMING	44
2.18 PARAMETERS PROGRAM SCAN	45
OPERATING NOTE	46
1 CLERK SIGN ON	46
1.1 IN CASE OF 4 CLERKS (SYSTEM OPTION 28's VALUE 'C' = 0)	47
1.1.1 PUSH BUTTON SIGN ON	46
1.1.2 SECRET CODE SIGN ON	46
1.2 IN CASE OF 15 CLERKS (SYSTEM OPTION 28's VALUE 'C' = 4)	46
1.2.1 PUSH BUTTON SIGN ON	47
1.2.2 SECRET CODE SIGN ON	47
2 CLERK SIGN OFF	47
2.1 IN CASE OF 4 CLERKS (SYSTEM OPTION 28's VALUE 'C' = 0)	47
2.2 IN CASE OF 15 CLERKS (SYSTEM OPTION 28's VALUE 'C' = 4)	47
3 REAL CLERK KEY ENTRY	47
4 CLEARING AN ERROR CONDITION	47
5 NO SALE OPERATION	48
6 NON-ADD NUMBER ENTRIES	48
7 PRICE INQUIRY OPERATION	48
8 DEPARTMENT ENTRIES	49
8.1 OPEN DEPARTMENT ENTRIES	49
8.2 PRESET DEPARTMENT ENTRIES	50
8.3 GALLONAGE DEPARTMENT ENTRIES	51
9 PLU (PRICE LOOK UP) ENTRIES	51
9.1 OPEN PLU ENTRIES	51
9.2 PRESET PLU ENTRIES	53

9.3 PLU TO PLU CHAIN OPERATION	54
9.4 PLU ENTRIES BY CODE	54
10 SINGLE ITEM DEPARTMENT OR PLU ENTRIES	55
10.1 SINGLE ITEM PRESET ENTRIES	55
10.2 SINGLE ITEM OVERRIDE ENTRIES	55
11 COMPUTATION OF VAT (Value Added Tax)	55
11.1 INCLUSIVE VAT SYSTEM	55
11.2 EXCLUSIVE VAT SYSTEM	56
12 % KEY ENTRIES	57
12.1 PERCENT RATE DISCOUNT / SURCHARGE	57
12.1.1 ITEM DISCOUNT / SURCHARGE	58
12.1.2 SALE DISCOUNT / SURCHARGE	58
12.2 AMOUNT DISCOUNT / SURCHARGE	58
12.2.1 ITEM DISCOUNT / SURCHARGE	58
12.2.2 SALE DISCOUNT / SURCHARGE	58
13 MERCHANDISE RETURN OPERATION	59
14 VOID OPERATION	59
14.1 VOID OF A LAST ITEM ENTRY (ERROR CORRECT)	59
14.2 VOID OF A PREVIOUS ITEM ENTRY	59
14.3 VOID OUTSIDE OF A SALE	60
14.4 CANCEL (VOID 4)	60
15 ADD CHECK OPERATION	61
16 TENDERING OPERATION	61
16.1 CASH TENDERING	61
16.2 PRESET CASH TENDERING	62
16.3 CHEQUE TENDERING	62
16.4 CHARGE TENDERING	62
16.5 SPLIT TENDERING	63
16.6 TENDERING WITH CURRENCY CONVERSION	64
16.7 POST TENDERING	64
17 CHEQUE CASHING	65
18 RECEIVED ON ACCOUNT OPERATION	66
19 PAID OUT OPERATION	66
20 TABLE MANAGEMENT	67
20.1 TRANSACTION	67
20.2 CONSOLIDATED RECEIPT PRINTING	67
21 CASHIER OVERLAP	69
21.1 TRANSACTION	69

21.2 CONSOLIDATED RECEIPT PRINTING	69
22 PRINTING A BUFFERED RECEIPT OPERATION	71
23 VALIDATION OPERATION	72
24 RECEIPT MESSAGE PRINTING OPERATION	73
24.1 PREAMBLE MESSAGE	73
24.2 POSTAMBLE MESSAGE	73
25 TRAIN MODE	74
REPORT AND BALANCING	75
1 REPORT MODES	76
2 CASH DECLARATION	76
3 REPORTS	77
3.1 OPEN TABLE (OR OPEN CLERK) REPORT	77
3.2 FINANCIAL REPORT	78
3.3 TIME REPORT	79
3.4 PLU REPORT	80
3.5 FROM / TO PLU REPORT	80
3.6 IN-DRAWER REPORT	81
3.7 DAILY SALES REPORT	81
3.8 INDIVIDUAL CLERK REPORT	82
3.9 FROM / TO DEPARTMENT REPORT	83
3.10 DEPT REPORT	83
TROUBLE SHOOTING	84
MEMORY PROTECTION BATTERY	84
SPECIFICATION	84
APPENDIX	84
1 CHARACTER TABLE CODE	85
2 ALPHA-NUMERIC KEYBOARD LAYOUT	86
2.1 ER-5115 ALPHA-NUMERIC KEYBOARD LAYOUT	86
2.2 ER-5140 ALPHA-NUMERIC KEYBOARD LAYOUT	87
3 COMMUNICATION INTERFACE	88
3.1 PIN DESCRIPTION FOR SERIAL INTERFACE	88
3.2 CABLE SPECIFICATION	88
4 COMMUNICATION WITH PC	89
5 PRINTING ON THE ROLL PRINTER	89
6 SCALE	90
6.1 DIRECT SCALE ENTRY	90
6.2 MANUAL WEIGHT ENTRY	90

FEATURES

- * Two-station printer with one-line validation capability.
- * Front and rear (pop-up) displays.
- * 6-position control locks.
- * 24 hour time clock with automatic date change.
- * 15 departments (ER-5115) / 40 departments (ER-5140).
- * 1000 open or preset PLUs.
- * 4 push-button clerks and 15 soft clerks with separate report totals.
- * 4 VAT or straight percentage TAX.
- * CANCEL function.
- * Post tendering.
- * Preset cash tendering.
- * Table management / Cashier overlap
- * Management reports.
 - Daily and period-to-date financial, time, PLU and clerk report.
 - Daily sales report.
 - Open table (or Open clerk) report.
 - Optional compulsory cash declaration.
- * Train mode.
- * Cash drawer compulsory.
- * Receipt on/off function.
- * Communication
 - Download the programming contents from PC, Upload the programming contents and reports to PC.
 - Slip printer
 - Kitchen printer
 - Scale
- * Euro Currency Conversion (Curr Conv1) + (Curr Conv2)

KEYBOARD LAYOUT

1 ER-5115 KEYBOARD LAYOUT

RECEIPT FEED	DETAIL FEED	RECEIPT ON/OFF	RECEIPT	VALID	PLU	CLERK 1	CLERK 2	CLERK 3	CLERK 4
VOID	CHECK #	CLEAR	#/NS	X/TIME	5	10	15	RECD ACCT	PAID OUT
MDSE RETURN	TAX	7	8	9	4	9	14	ADD CHECK	CHARGE 1
CANCEL	CONV 1	4	5	6	3	8	13	CHECK TENDER	CHARGE 2
PRICE INQ.	CONV 2	1	2	3	2	7	12	CHEQUE	SUBTL
% 1	% 2	0	00	.	1	6	11	CASH/TEND	

Important Note: ER5115 only.

The keyboard design for the Cash/Tend & Subtotal keys has changed with the new Euro Eprom.

The above style is the new keyboard for the Euro Eprom.

Pre-Euro keyboards will have the design shown on right.

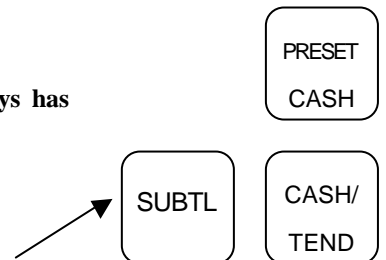

2 ER-5140 KEYBOARD LAYOUT

RECEIPT FEED	DETAIL FEED	RECEIPT ON/OFF	RECEIPT	VALID	#/NS	TAX	PLU		RECD ACCT	PAID OUT	CLERK 1	CLERK 2	CLERK 3	CLERK 4
VOID	CHECK #	CLEAR		X/time	5	10	15	20	25	30	35	40	CHECK TENDR	CHARGE 1
MDSE RETUR	ADD CHECK	7	8	9	4	9	14	19	24	29	34	39	PRESET CASH	CHARGE 2
CANCEL	CONV 1	4	5	6	3	8	13	18	23	28	33	38	PRESET CASH	CHEQUE
PRICE INQ.	CONV 2	1	2	3	2	7	12	17	22	27	32	37	SUBTOTAL	
% 1	% 2	0	00	.	1	6	11	16	21	26	31	36	CASH/TEND	

FUNCTION KEY DESCRIPTION

<u>KEY</u>	<u>DESCRIPTION</u>
1, 2 ... 9, 0, 00	Use these numeric keys for all numeric entries on the cash register.
ADD CHECK	Use this key to combine individual guest checks that will be tendered together.
CANCEL	Use this key to cancel the present incomplete transactions without updating the departments, PLUs or function key totals.
CASH/TEND	Use this key to finalize a sale paid with cash. Enter the amount tendered before pressing the "CASH/TEND" key for change calculation.
CHARGE 1, 2	Use these keys to finalize a sale paid with a charge account.
CHECK #	Use this key to specify the table number on table management.
CHECK TENDER	Use this key to tender a table as open status.
CHEQUE	Use this key to finalize a sale that is paid by cheque.
CLEAR	Use this key to clear the incorrect entries made on the 10 numeric keys and error conditions.
CLERK 1, 2, 3, 4	Use these four keys to log on clerks for operation and reports. <i>A clerk must be logged on before the cash register will operate.</i>
CONV 1, 2	Use these keys to convert a home currency to the equivalent of another country's currency. These keys are allowed after the "SUBTOTAL" key, convert and re-display the subtotal at a preprogrammed exchange rate. Tendering is allowed after using the currency conversion function. The change amount is calculated in home currency. The amount of foreign currency tendered is stored in a separated total on the financial report, but not added to the drawer total.
DECIMAL (.)	Use this key for decimal multiplication.
DEPARTMENTS	Use these keys to make entries during a sale.
DETAIL FEED	Press this key to advance the detail tape.
MDSE RETURN	Use this key to return merchandise outside of a sale. MDSE RETURN activity reports to a total on the financial report.
#/NS	Use this key to open the cash drawer outside of a sale or to enter numbers that appear on the receipt and detail tapes but do not affect the sale total.
% 1, % 2	Use these keys to register discount and surcharge. Depending on programming, these keys can be used to register percent or amount and added to an item or entire sale.
PLU	Use this key to register a Price Look Up (PLU).

<u>KEY</u>	<u>DESCRIPTION</u>
PAID OUT	Use this key to register media removed from the cash drawer. (= Paid Out)
PRESET CASH	Use this key to finalize a sale paid with cash. These keys are preset amount cash tendering keys which have programmable values. By pressing this key at the end of a transaction, the preset amount is automatically tendered and the sale is finalized as a cash transaction.
PRICE INQ.	Use this key to know a HALO or preset amount of a department or PLU. (= Price Inquiry)
RECD ACCT	Use this key to register cash and cheque added to the cash drawer. (= Received Account)
RECEIPT	Use this key to issue the buffered receipt.
RECEIPT FEED	Press this key to advance the customer's receipt tape.
RECEIPT ON/OFF	Use this key to turn the receipt printer on or off. When the 'RECEIPT OFF' sign is illuminated on the display panel, the receipt printer will be turned off.
SUBTL	Use this key to display a subtotal. (= SUBTOTAL)
TAX	Use this key to breakdown the amount due including value added tax or to shift the tax status of a particular department or PLU.
VALID	Use this key to print one line validation on a check or slip.
VOID	Use this key to correct entries before a sale is finalized.
X/TIME	Use this key for multiplication, split pricing and triple multiplication.

CONTROL LOCK

POSITION	USE
VOID	Void outside of a sale.
OFF	The cash register will not operate.
REG	All normal operations.
X	To issue X level reports. Also used for manager control of voids & merchandise return.
Z	To issue Z level reports. To reset totals to zero.
P	To program the ECR (Electronic Cash Register)

CONTROL KEYS

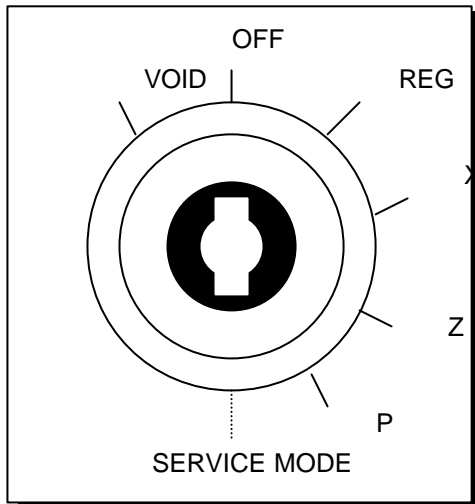

' REG' key : " OFF" ~ " REG"

' VD' key : " VOID" ~ " X"

' Z' key : " VOID" ~ " Z"

' P' key : " VOID" ~ " P"

' C' key : All position

DISPLAY

This cash register has a **front (or operator) display** and a **pop up display**.

The front display has a **indicator lights**. These lights provide only the operator with information about the operation of the cash register.

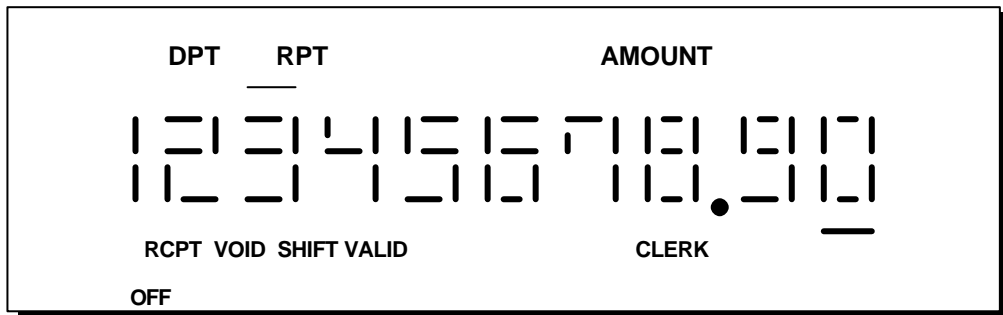

DISPLAY SYMBOLS

SYMBOL	CONTENTS
C	Indicates that the amount displayed is a due as change .
=	Indicates that the amount displayed is a total .
-	Indicates that the amount displayed is negative . This symbol shows directly in front of negative amount.
S	Indicates that the amount displayed is a subtotal .
F	Indicates that a table on table management or a clerk on cashier overlap is temporarily finalized as open status .
SP	Indicates that validation is required .
PP	Indicates paper jam . Please turn the power off and remove the paper in the printer, turn the power on again.
PE	Indicates paper ending . Please remove the printer cover and replace the paper. And press the "CLEAR" key to print continually.
CL	Indicates that a clerk must be signed on for operating in the 'X' or 'Z' mode.
SE	Indicates that the maximum slip lines is reached . Please insert the new slip into the slip printer and press the " CHECK TENDER "

	key.
--	------

SYMBOL	CONTENTS
E 1	Indicates an error condition . Press the " CLEAR " key to clear this condition.
E 2	Indicates that the cash drawer must be closed .
E 4	Indicates that NON-ADD NUMBER should be entered.
E 5	Indicates that the ADD CHECK operation must be performed.
E 6	Indicates that the cash declaration operation must be performed.
E 8	Indicates that now a table is open .
E 9	Indicates that all the open tables or clerks must be finalized .
E 10	Indicates that the sale data is too big . Please issue all Z report . ('100' – 'SUBTL' in Z mode)
E 11	Indicates that the scale runtime over .
E 12	Indicates that the scale is not measurable things on the scale.
E 13	Indicates that the open drawer warning tone sounds by the open drawer alarm. Please close the cash drawer .
E 14	Indicates that the slip printer is disconnected . Please check if the slip printer is connective.
NO PAP	Indicates that the paper run out on the EPSON TM-290 ? . Please insert the paper to the slip printer and press the " CLEAR " key.

SYMBOL	CONTENTS (related to CHECKLINE EFT terminal)
E 15	General error like disconnection, timeout and so on.
E 16	ZERO amount
E 17	Call card issuer
E 18	Prevalid date
E 19	Expiry date
E 20	No payee
E 21	No store
E 22	Card rejected
E 23	Over floor limit
E 24	Over trans limit
E 25	Illegal card use
E 26	Sensor problem
E 27	Signature reject
E 28	Function aborted

PROGRAMMING NOTE

This ECR (Electronic Cash Register) 's programming is easy.

In this manual, the programming steps are explained with **flow chart boxes**.

Each box represents a key on the keyboard.

The flow chart shows each key stroke you need to complete the programming.

Enter the keys in the flow chart from left to right.

DEFAULT PROGRAM : *This machine arrives with a default or " generic" program already installed.*

Program options are set to 0(zero), unless otherwise noted, which means the machine is operational right out-of-the-box.

1 SERVICE MODE PROGRAMMING

Service mode programming is the initial programming that is required when the register is new "out-of-the-box".

Service mode programming is also used to return the register to this condition.

1.1 RAM CLEARING

1.1.1 INITIAL CLEAR

Keyboard lock-ups and constant error conditions may be cleared by the following procedure.

This procedure will not effect register programming, or clear previously stored totals in RAM memory.

(1) Turn the keylock to the '**P**' **position** and press the "**SUBTL**" **key**.

(2) While holding the "**SUBTL**" **key down**, **power** the register **off**, and back **on**.

Continue to hold the " SUBTL" key down until the receipt printer stops printing and the display shows 0.00.

* INITIAL CLEAR *

1.1.2 CLEARING TOTALS FROM MEMORY

A. ALL MEMORY RAM CLEAR

All programming and totals are cleared.

Use this procedure the first time when the cash register is programmed.

B. RESET ALL TOTALS & COUNTERS

All totals and counters are cleared. (Consecutive NO. , Z-Counter, Grand total)

This procedure will not effect register programming.

C. RESET GRAND TOTAL ONLY

The Grand total is only cleared.

(1) **Unplug** the cash register.

(2) Insert **lock key marked ' C '** into the control lock and **turn clockwise, past** the position marked **' P '**, to the **' SERVICE MODE '** (Master Clear position). This position is not marked on the control lock, but the 'C' key will travel to this position.

(3) Choose the desired operation from those listed below.

While holding **the SPECIFIED key down, plug-in** the cash register.

Continue to hold the specified key down until the receipt printer stops printing and the display shows 0.00.

KEY	TYPE
00	ALL MEMORY RAM CLEAR
CHEQUE	RESET ALL TOTALS & COUNTERS
CASH/TEND	RESET GRAND TOTAL ONLY

* ALL MEMORY RAM CLEAR * * RESET ALL TOTALS & COUNTERS * * RESET GRAND TOTAL ONLY *

1.2 SETTING THE NUMBER OF DEPARTMENTS

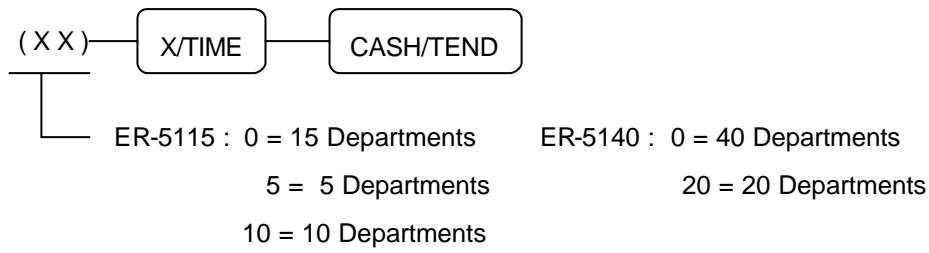

EX) If you want to program 5 departments system.



NOTE : In order to reprogram the number of departments available, firstly the register should be RAM cleared and then all programming must be re-entered.

2 P MODE PROGRAMMING

2.1 DATE & TIME PROGRAMMING

2.1.1 DATE PROGRAMMING

- (1) Enter *the date* in the form of **DD MM YY** or **MM DD YY** or **YY MM DD** and **week**.
(The order of date is set by **SYSTEM OPTION ADDRESS 25 : Page 25**)
- (2) Press the " **X/TIME** " key.

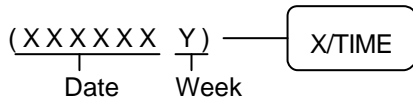

2.1.2 TIME PROGRAMMING

- (1) Enter *standard military time* in the form of **HH MM**.
- (2) Press the " **X/TIME** " key.

EX) 25 DECEMBER 1998, FRIDAY 12 : 00 noon

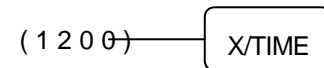
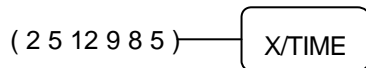

In military time noon = 1200
midnight = 0000
1 : 30 PM = 1330
and so on.

WEEK TABLE

WEEK VALUE :			
SUNDAY	0	THURSDAY	4
MONDAY	1	FRIDAY	5
TUESDAY	2	SATURDAY	6
WEDNESDAY	3		

2.2 REGISTER NUMBER PROGRAMMING

- (1) Enter the *register number* up to **4 digits**.
- (2) Press the " **MDSE RETURN** " key.

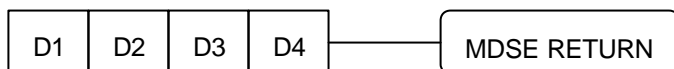

2.3 TAX PROGRAMMING

You can program **4 tax rates** on this cash register.

This cash register can calculate tax by **two methods** :

- A. VAT (Value Added Taxes) : **Inclusive VAT**
- B. Straight percentage taxes : **Exclusive VAT**

IMPORTANT : To program tax as INCLUSIVE, set SYSTEM OPTION ADDRESS 4 to 0.

To program tax as EXCLUSIVE, set SYSTEM OPTION ADDRESS 4 to 1.

NOTE : If you clear RAM, the machine has the INCLUSIVE TAX SYSTEM.

2.4 VAT RATE PROGRAMMING

(1) Press the **VAT number (1, 2, 3 or 4)** and the " **TAX**" key.

(2) Enter the **percentage** of tax from the numeric key pad.

You must use **the decimal (.) key**.

EX) 10 % tax by entering : 1 0 . 0 0 0

6.25 % tax by entering : 6 . 2 5 0

NOTE : You must enter 3 number after the decimal key.

(3) Press the " **SUBTL**" key.

If you want to use the **TAX ROUNDING SYSTEM**, refer to **SYSTEM OPTION ADDRESS 38**

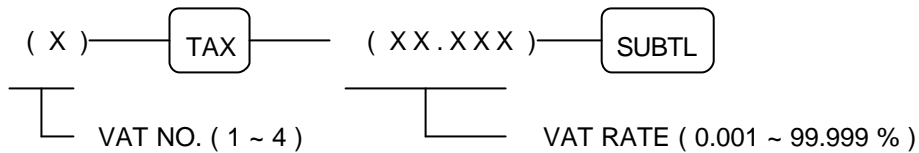

2.5 CLERK SECRET CODE & DRAWER ASSIGNMENT PROGRAMMING

NOTE : If you want to use 15 clerks system, you should set the SYSTEM OPTION ADDRESS 28 to 4 (Page 25).

When you want to use the **CLERK CODE SYSTEM**, you should set the **SYSTEM OPTION ADDRESS 28**.

This programming assigns a clerk code number to each clerk. **The code number** is used by the clerk to **log on** for operations. **Although you don't program clerk code, each clerk has a default code that is same as the clerk number.**

(1) Press the one of " **CLERK (1, 2, 3 or 4)**" keys. **Any clerk key makes no difference.**

(2) Press the **clerk number (1 ~ 15)** and press the " **DECIMAL POINT (.)**" key.

(3) Enter the **clerk secret code up to 6 digits**, and then press the " **#/NS**" key.

(4) Press the **drawer number ' 1 ' or ' 2 '** and then press the " **CASH/TEND**" key to finalize the clerk

programming.

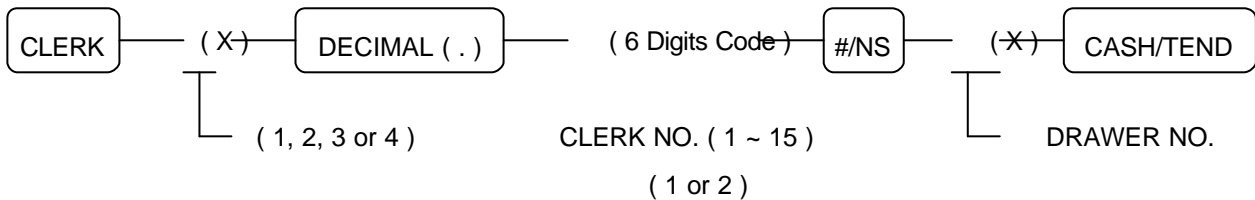

NOTE : Default drawer assignment for all clerks is drawer 1.

2.6 SYSTEM OPTION PROGRAMMING

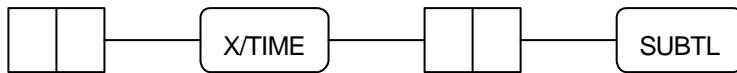

ADDRESS STATUS

NOTE : Address 1 ~ 9 should not be entered 01 ~ 09, enter single digit 1 ~ 9.

The value " 0" is default status.

ADDRESS	OPTION	VALUE	STATUS
1	Subtotal without tax will be printed on the receipt & journal. Does not require press of the "SUBTL" key. Print ORDER# on receipt	a YES = 1 NO = 0 b YES = 2 NO = 0	SUM = a + b
2	Tax amount charged will be printed on the receipt at finalization. The printed tax amount on receipt at finalization is combined = <i>* Itemized tax printing lists each rate separately, itemized =</i> <i>while combined tax printing lists the total of all taxes.</i> <i>Tax print (first option) must be set to " YES" to allow this option.</i> Print taxable totals .	a YES = 1 NO = 0 b YES = 2 NO = 0 c YES = 4 NO = 0	SUM = a + b + c
3	Tax symbol is printed for item. VAT percent rate is printed. Net sale amount is automatically printed by VAT break down . <i>(Only inclusive VAT)</i>	a YES = 0 NO = 1 b YES = 2 NO = 0 c YES = 4 NO = 0	SUM = a + b + c
4	Tax is figured by inclusive VAT . Tax is figured by exclusive VAT .	a 0 1	A
5	Cash declaration is compulsory before X/Z reports. Cash drawer does not open when reports are run.	a YES = 1 NO = 0 b YES = 2 NO = 0	SUM = a + b
6	GRAND total is not printed on financial report .	a YES = 1 NO = 0	A
7	Skip media totals with zero activity on financial report . GROSS total is not printed on financial report . MODE VOID and RETURN are not printed on financial and clerk report .	a YES = 0 NO = 1 b YES = 2 NO = 0 c YES = 4 NO = 0	SUM = a + b + c
8	Consecutive number resets after Z1 financial report . GRAND total resets after Z1 financial report . Print full clerk report . <i>(See a clerk report section.)</i>	a YES = 1 NO = 0 b YES = 2 NO = 0 c YES = 4 NO = 0	SUM = a + b + c
9	PLU is registered by code = sequential index (1 ~ 1000) =	a 1 0	a
10	HASH department and PLU operations add to NET sales . Print PLUs and DEPT.s with zero totals on report . Print sales rate on DEPT. / PLU reports .	a YES = 1 NO = 0 b YES = 2 NO = 0 c YES = 4 NO = 0	SUM = a + b + c

ADDRESS	OPTION	VALUE	STATUS
11	Disable department / PLU preset/HALO override Allow 8-digit DEPT. and PLU amount entry.	a	YES = 1 NO = 0
		b	YES = 2 NO = 0
12	Negative and zero sales total are not allowed. Inhibit printing of positive DEPT. and PLU entries on journal.	a	YES = 1 NO = 0
		b	YES = 2 NO = 0
13	Allow the post tender function.	a	YES = 1 NO = 0
14	VOID function is only allowed in the ' X' control lock position. Compulsory validation on VOID function. VOID function is inactive.	a	YES = 1 NO = 0
		b	YES = 2 NO = 0
		c	YES = 4 NO = 0
15	CANCEL function is only allowed in the ' X' control lock position. CANCEL function is inactive.	a	YES = 1 NO = 0
		b	YES = 2 NO = 0
16	RETURN function is only allowed in the ' X' control lock position. Compulsory validation on RETURN function. RETURN function is inactive.	a	YES = 1 NO = 0
		b	YES = 2 NO = 0
		c	YES = 4 NO = 0
17	% key function is only allowed in the ' X' control lock position. Compulsory validation on % key function. % key function is inactive.	a	YES = 1 NO = 0
		b	YES = 2 NO = 0
		c	YES = 4 NO = 0
18	RECD ACCT & PAID OUT are only allowed in the ' X' control lock position. Compulsory validation on RECD ACCT & PAID OUT. RECD ACCT & PAID OUT are inactive.	a	YES = 1 NO = 0
		b	YES = 2 NO = 0
		c	YES = 4 NO = 0
19	CHEQUE-CASHING is only allowed in the ' X' control lock position. Compulsory validation on CHEQUE-CASHING. CHEQUE-CASHING is inactive.	a	YES = 1 NO = 0
		b	YES = 2 NO = 0
		c	YES = 4 NO = 0
20	Validation amount is amount tendered = amount of sale = Allow multiple validations.	a	YES = 1 NO = 0
		b	YES = 2 NO = 0
21	Allow multiple buffered receipts. Buffered receipt is only issued on the " RECEIPT OFF" position. When pushing the " #/NS" key to open the drawer, receipt ticket is not issued.	a	YES = 1 NO = 0
		b	YES = 2 NO = 0
		c	YES = 4 NO = 0

ADDRESS	OPTION	VALUE	STATUS	
22	Print the " CASH" when only SINGLE ITEM is registered. Print sale item no. Subtotal is printed when the " SUBTL" key is pressed.	a	YES = 1 NO = 0	SUM = a + b + c
		b	YES = 2 NO = 0	
		c	YES = 4 NO = 0	
23	Inhibit TIME print on receipt and journal. Inhibit MACHINE NO. print on receipt and journal. Inhibit Z REPORT ISSUING COUNTER print on receipt and journal.	a	YES = 1 NO = 0	SUM = a + b + c
		b	YES = 2 NO = 0	
		c	YES = 4 NO = 0	
24	Inhibit DATE print on receipt and journal. Inhibit CONSECUTIVE NO. print on receipt and journal.	a	YES = 1 NO = 0	SUM = a + b
		b	YES = 2 NO = 0	
25	The date format is * Same in validation	a	Day, Month and Year = 0 Month, Day and Year = 1 Year, Month and Day = 2	a
26	Decimal for print and display :	a	No decimal = 1 Set at one place = 2 Set at three places = 3 Set at two places = 0	a
27	Enter the HDLO (High Digit Lock Out) For the total amount allowed for RECD ACCT & PAID OUT transactions.	a	0.01 ~ 0.09 = 1 0.01 ~ 0.99 = 2 0.01 ~ 9.99 = 3 0.01 ~ 99.99 = 4 0.01 ~ 999.99 = 5 0.01 ~ 9999.99 = 6 0.01 ~ 99999.99 = 7	a
28	Clerks are	a	Pop-up = 1 Stay-down = 0	SUM = a + b + c
		b	Secret sign-on code = 2 Push button = 0	
		c	15 Clerks = 4 4 Clerks = 0	
29	Allow clerk change without clerk sign-off operation.	a	YES = 1 NO = 0	a
30	Home Currency Symbol. Other logos (Refer to page 89 : " CHARACTER CODE TABLE")	a	(¤ = 91, £ = 0, Pts = 92) 0 - 122	a
31	Disable NON-ADD NUMBER function. " TRAIN MODE START" message is not printed when train mode starts. " TRAIN MODE END" message is not printed when train mode ends.	a	YES = 1 NO = 0	SUM = a + b + c
		b	YES = 2 NO = 0	
		c	YES = 4 NO = 0	
32	Disable NO SALE function. Inhibit NO SALE after NON-ADD NUMBER entry. Enforce NON-ADD NUMBER entry at the beginning of sale.	a	YES = 1 NO = 0	SUM = a + b + c
		b	YES = 2 NO = 0	
		c	YES = 4 NO = 0	
33	Number of digits required for NON-ADD NUMBER entry. ('0' allows any length, 1 ~ 8 digits)	a	0 1 ~ 8	a

<p>Under tendering by " CASH/TEND" is not allowed.</p> <p>Validation on " CASH/TEND" tendering is compulsory.</p>	b	YES = 2 NO = 0	= a + b + c
	c	YES = 4 NO = 0	

ADDRESS	OPTION	VALUE		STATUS
50	Amount tender is compulsory on " CHEQUE" tendering.	a	YES = 1 NO = 0	SUM = a + b + c
	Under tendering by " CHEQUE" is not allowed.	b	YES = 2 NO = 0	
	Validation on " CHEQUE" tendering is compulsory.	c	YES = 4 NO = 0	
51	NON-ADD NUMBER entry is compulsory on " CHARGE 1" tendering.	a	YES = 1 NO = 0	SUM = a + b + c
	Over tendering by " CHARGE 1" is allowed.	b	YES = 2 NO = 0	
	Validation on " CHARGE 1" tendering is compulsory.	c	YES = 4 NO = 0	
52	NON-ADD NUMBER entry is compulsory on " CHARGE 2" tendering.	a	YES = 1 NO = 0	SUM = a + b + c
	Over tendering by " CHARGE 2" is allowed.	b	YES = 2 NO = 0	
	Validation on " CHARGE 2" tendering is compulsory.	c	YES = 4 NO = 0	
53	Clerk key : Button key = Real clerk key =	a	0 1	a
54	Printer type : No printer = EPSON TM-290 = EPSON TM-300(D) = EPSON TM-T80 = CITIZEN iDP 3540/3541 = STAR SP200 = SAMSUNG SRP-100/200 =	a	0 1 2 3 4 5 6	a
55	Feed line after printing on the roll printer : (Default = 7Line)	a	0 ~ 99	a
56	EAT-IN / TAKE-OUT / DRIVE-THRU procedure compulsory before tendering.	a	YES = 1 NO = 0	a
57	Department LEVEL Keys are Stay-down = Item pop-up = Ticket pop-up =	a	0 1 2	a
58	Disable "LEVEL" Key: LEVEL 1 = LEVEL 2 = LEVEL 3 =	a	1	SUM = a + b + c
		b	2	
		c	4	
59	Maximum slip line	a	0 ~ 99	a
60	Feed lines before printing on the slip printer	a	0 ~ 99	a
61	Reserved for future use			
62	Characters entered by: Alpha Numeric Keyboard = Character Code =	a	0 1	a
63	Conversion rate 1 currency character code (Ī = 91, £ = 0, Pts =92)		0~122	
64	Conversion rate 2 currency character code (Ī = 91, £ = 0, Pts =92)		0~122	
65	Enable printing Conversion 1 TOTAL amount	a	YES = 1 NO = 0	SUM = a + b + c
	Enable printing Conversion 1 TENDERED amount	b	YES = 2 NO = 0	
	Enable printing Conversion 1 CHANGE amount	c	YES = 4 NO = 0	

66	Base currency is:	a	Euro = 1 Local = 0	a
ADDRESS	OPTION		VALUE	STATUS
67	When using currency Conversion 2 , print TOTAL for both currencies	a	YES = 1 NO = 0	SUM = a + b + c
	When using currency Conversion 2 , print TENDERED amount for both currencies	b	YES = 2 NO = 0	
	When using currency Conversion 2 , print CHANGE for both currencies	c	YES = 4 NO = 0	
68	Disable printing in FOREIGN AMOUNT during conversion operation	a	YES = 1 NO = 0	a

The following system options are applicable to the 5115/5140

59	Characters entered by: Alpha Numeric Keyboard = Character Code =	a	0	a
			1	
60	Conversion rate 1 currency character code (Î = 91, £ = 0, Pts =92)		0~122	
61	Conversion rate 2 currency character code (Î = 91, £ = 0, Pts =92)		0~122	
62	Enable printing Conversion 1 TOTAL amount	a	YES =1 NO = 0	SUM = a + b + c
	Enable printing Conversion 1 TENDERED amount	b	YES =2 NO = 0	
	Enable printing Conversion 1 CHANGE amount	c	YES=4 NO = 0	
63	Base Currency is:	a	Euro = 1 Local = 0	a
64	When using currency Conversion 2 , print TOTAL for both currencies	a	YES = 1 NO = 0	SUM = a + b + c
	When using currency Conversion 2 , print TENDERED amount for both currencies	b	YES = 2 NO = 0	
	When using currency Conversion 2 , print CHANGE for both currencies	c	YES = 4 NO = 0	
65	Disable printing in FOREIGN AMOUNT during conversion operation	a	YES = 1 NO = 0	a

2.7 DESCRIPTOR PROGRAMMING

You can program descriptors for each **DEPARTMENT**, **PLU**, **CLERK**, **DEPARTMENT GROUP**, **SOME FUNCTION KEYS** and **RECEIPT MESSAGE** using the following programming procedure.

2.7.1 PROGRAMMING

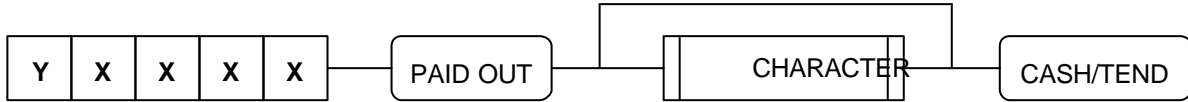

NOTE : Refer to " **ALPHA-NUMERIC KEYBOARD LAYOUT**" (Page 90, 91) for entering characters.

STANDARD DESCRIPTOR	ADDRESS	NUMBER	CHARACTER LENGTH	REMARKS
	Y	X X X X		
DEPARTMENT	1	0001 ~ 0015 0001 ~ 0040	12 CHAR. 12 CHAR.	- ER-5115 - ER-5140
PLU	2	0001 ~ 1000	12 CHAR.	
CLERK	3	0001 ~ 0015	12 CHAR.	
GROUP0	3	0 0 1 6	12 CHAR.	
GROUP1	3	0 0 1 7	12 CHAR.	
GROUP2	3	0 0 1 8	12 CHAR.	
GROUP3	3	0 0 1 9	12 CHAR.	
GROUP4	3	0 0 2 0	12 CHAR.	
GROUP5	3	0 0 2 1	12 CHAR.	
GROUP6	3	0 0 2 2	12 CHAR.	
GROUP7	3	0 0 2 3	12 CHAR.	
GROUP8	3	0 0 2 4	12 CHAR.	
GROUP9	3	0 0 2 5	12 CHAR.	
CASH	3	0 0 2 6	12 CHAR.	
CHEQUE	3	0 0 2 7	12 CHAR.	
CHG1	3	0 0 2 8	12 CHAR.	
CHG2	3	0 0 2 9	12 CHAR.	
CHANGE	3	0 0 3 0	12 CHAR.	
TOTAL	3	0 0 3 1	12 CHAR.	
RECD ACCT	3	0 0 3 2	12 CHAR.	
PAID OUT	3	0 0 3 3	12 CHAR.	
NON-ADD#	3	0 0 3 4	12 CHAR.	
ADD CHECK	3	0 0 3 5	12 CHAR.	
NO SALES	3	0 0 3 6	12 CHAR.	
ERR CORRECT	3	0 0 3 7	12 CHAR.	
PREV VOID	3	0 0 3 8	12 CHAR.	
RETURN	3	0 0 3 9	12 CHAR.	
ALL CANCEL	3	0 0 4 0	12 CHAR.	
% 1	3	0 0 4 1	12 CHAR.	
% 2	3	0 0 4 2	12 CHAR.	
CONV 1	3	0 0 4 3	12 CHAR.	
CONV 2	3	0 0 4 4	12 CHAR.	
RCPT MSG	4	0001 ~ 0004	21 CHAR.	PREAMBLE
RCPT MSG	4	0005 ~ 0006	21 CHAR.	POSTAMBLE

2.7.2 DESCRIPTOR PROGRAMMING EXAMPLES

(1) DEPT.1 = APPLE

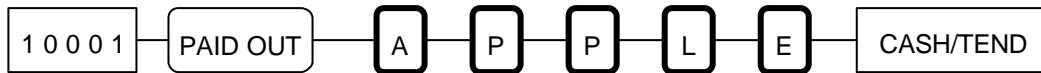

(2) PLU 10 = **ORANGE**

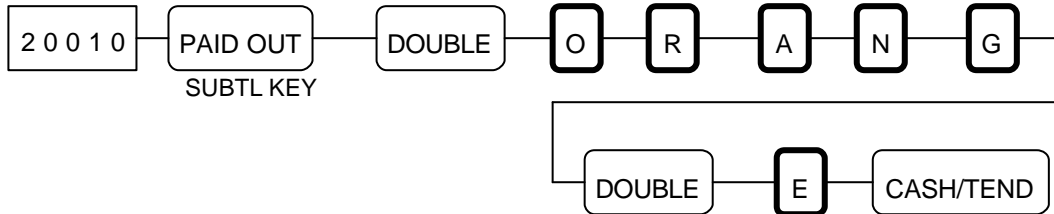

(3) CLERK 4 = JAMES



(4) PREAMBLE MESSAGE LINE 1 = **Thank You**

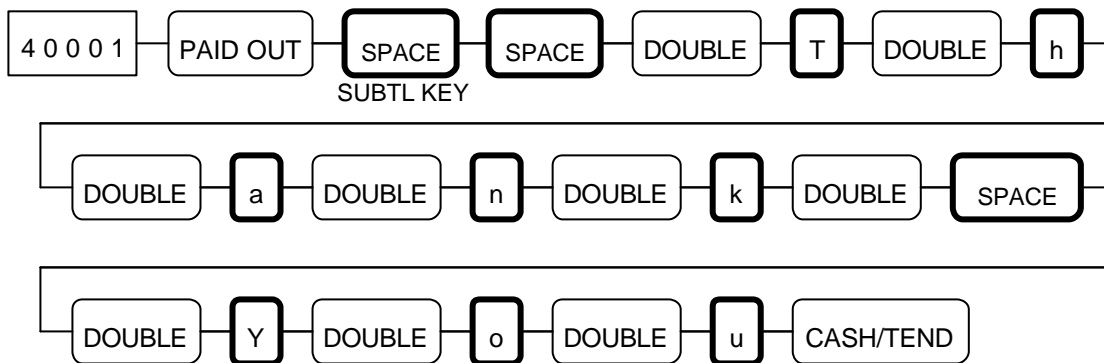

(5) POSTAMBLE MESSAGE LINE 1 = **Call Again**

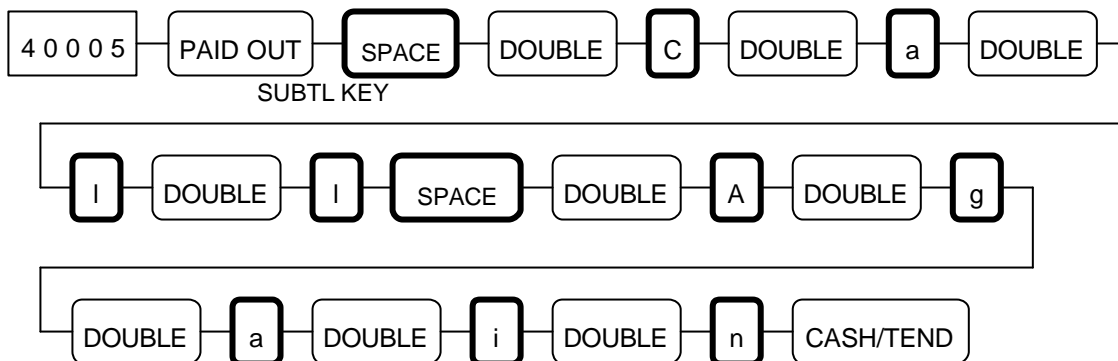

2.7.3 DESCRIPTOR PROGRAMMING SCAN

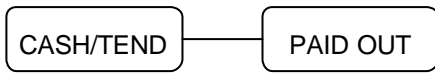

2.8 DEPARTMENT PROGRAMMING

* HASH Department *

- Typically **HASH department** may be used to register items such as **delivery charges** or **lottery sales** that a merchant may not want to appear in accumulated sales totals.
- Sales registered into **HASH department** do **not add** to the **grand total, gross sales total** and may also be **programmed not to add** to the **net sales total**.
- **HASH departments add** to the **total of each sale** and therefore are included in **all media** and the **drawer totals**. Like normal departments, **HASH departments** also add to a **total of all HASH departments and PLUs** on the **financial report**.
- **SYSTEM OPTION ADDRESS 10** is used to select whether **HASH department totals add** to the **net sales total** or not.

2.8.1 DEPARTMENT STATUS PROGRAMMING

A. PROGRAMMING OPTION

PROGRAMMING OPTION	VALUE			OPTION DIGIT
Department <i>GROUP NO.</i>	0 ~ 9			N 1
<i>Resettable counter, counter will increase.</i>	0			N 2
<i>Nonresettable counter, counter will increase.</i>	1			
<i>Resettable counter, counter will decrease.</i>	2			
<i>Nonresettable counter, counter will decrease.</i>	3			
<i>HASH department feature</i>	a	YES = 1	NO = 0	N 3 = a + b + c
<i>GALLONAGE department feature</i>	b	YES = 2	NO = 0	
<i>NON-ADD NUMBER compulsory</i>	c	YES = 4	NO = 0	
Department is <i>NEGATIVE</i> .	a	YES = 1	NO = 0	N 4 = a + b + c
Department is <i>SINGLE ITEM</i> .	b	YES = 2	NO = 0	
<i>VALIDATION compulsory</i>	c	YES = 4	NO = 0	
Department is <i>PRESET</i> .	0			N 5
Department is <i>OPEN (HALO)</i> .	1			
Department is <i>DISABLED</i> .	2			
Department is <i>not taxable</i> .	0			N 6
Department is taxable by <i>VAT 1</i> .	1			
Department is taxable by <i>VAT 2</i> .	2			
Department is taxable by <i>VAT 3</i> .	3			
Department is taxable by <i>VAT 4</i> .	4			
Department is taxable by <i>VAT 1 & 3</i> .	5			
Department is printed on <i>KITCHEN PRINTER</i>	a	YES = 1	NO = 0	N 7

B. PROGRAMMING

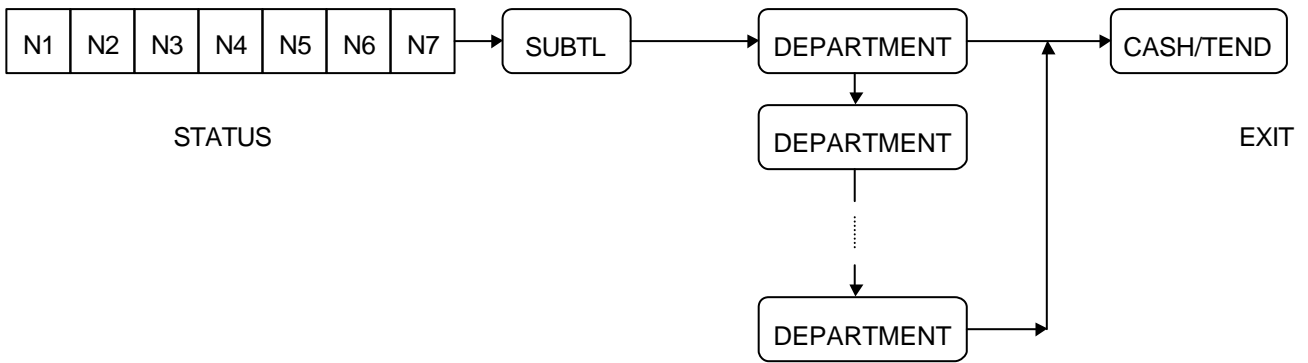

2.8.2 DEPARTMENT PRICE OR HALO PROGRAMMING

A zero amount entry for open department will set the HALO (High Amount Lock Out) at the maximum seven digits (99999.99) for standard department, and five digits (99.999) for gallonage department.

Zero preset departments are allowed.

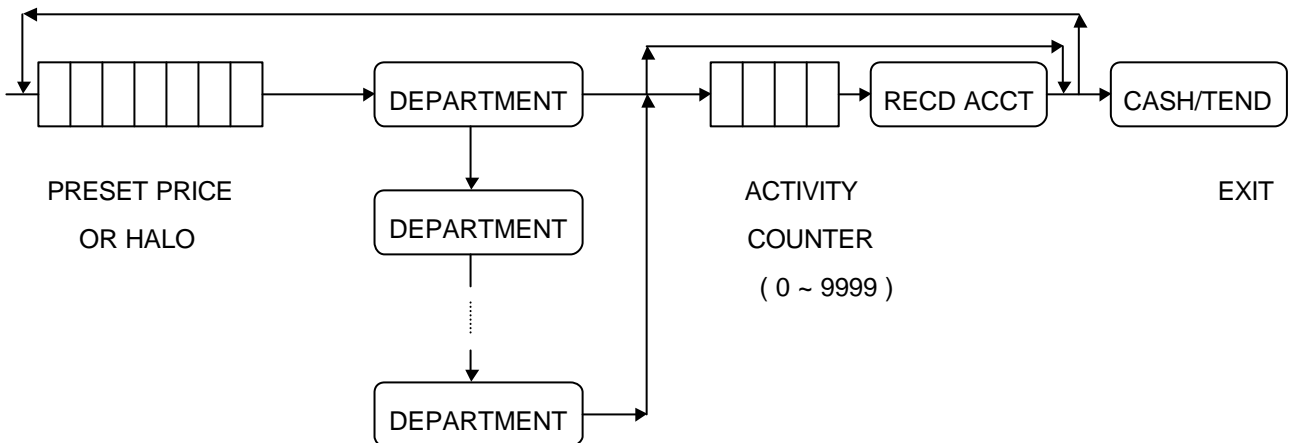

2.8.3 DEPARTMENT PROGRAMMING EXAMPLES

A. DEPARTMENT STATUS PROGRAMMING

EX 1) Program ' DEPT 1 ' and ' DEPT 2 ' . 'DEPT 1' and 'DEPT 2' are VAT 1 and KP items.

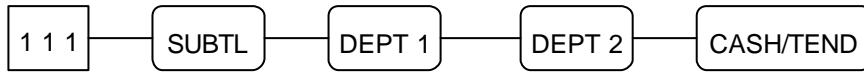

EX 2) Program ' DEPT 3 ' so it is a PRESET department, VAT 2 and a KP item.

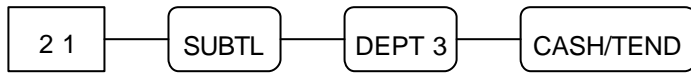

EX 3) Program ' DEPT 4 ' so it is a PRESET, SINGLE ITEM department and VAT 3.

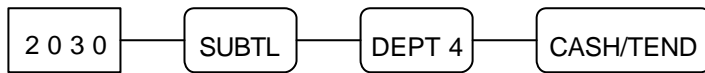

EX 4) Program ' DEPT 5 ' so it is a NEGATIVE PRESET and NON TAX with nonresettable and increasing counter.

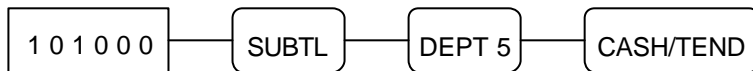

EX 5) Program ' DEPT 6 ' so it is a PRESET, VAT 1 & 3 and a KP item.



EX 6) Program ' DEPT 10 ' so it is a GALLONAGE and NON TAX.

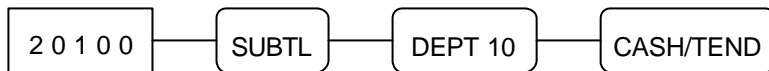

EX 7) Program ' DEPT 15 ' so it is accumulated to GROUP 7 and HASH, PRESET and VAT 4.

'DEPT 15' is a KP item.

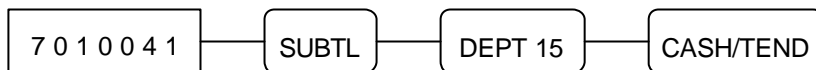

B. DEPARTMENT PRICE OR HALO PROGRAMMING

EX 1) Program ' DEPT 1' and ' DEPT 2' . 'DEPT 1' and 'DEPT 2' have a @99.99 HALO.

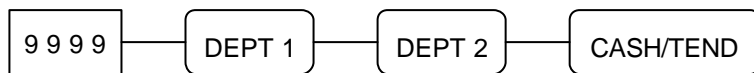

EX 2) Program ' DEPT 3' , ' DEPT 6' and ' DEPT 15' . These departments have a price @10.00.

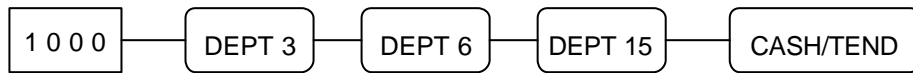

EX 3) Program ' DEPT 4' so it has a price @15.00.



EX 4) Program ' DEPT 5' so it has a price @1.00 and activity counter is 50.

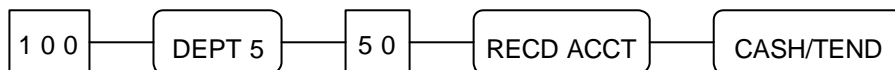

EX 5) Program ' DEPT 10' so it has a price @1.399 (Gallonage Price).

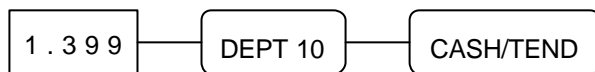

2.8.4 DEPARTMENT PROGRAMMING SCAN

- (1) Press the “ **CASH/TEND**” key.
- (2) Press **the first** “ **DEPARTMENT**” key you want to scan.
- (3) Press **the last** “ **DEPARTMENT**” key you want to scan.

If you want to scan only one department, press the same “ DEPARTMENT” key twice.

NOTE : The first department number £ The last department number

EX) To scan dept. 1 ~ 15

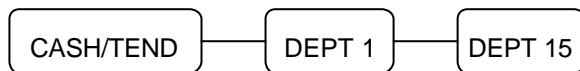

2.9 PLU PROGRAMMING

HASH PLU's operation is the same as HASH department operation.

PLU is registered by sequential index (1 ~ 1000) or by PLU code (1 ~ 99999999) that you program.

(SYSTEM OPTION ADDRESS 9, Page 23)

Although you don' t program PLU code, each PLU has a default code that is same as the PLU number.

2.9.1 PLU PROGRAMMING

A. PROGRAMMING OPTION

PROGRAMMING OPTION	VALUE			OPTION DIGIT
<i>Resettable counter, counter will increase.</i>	0			N 1
<i>Nonresettable counter, counter will increase.</i>	1			
<i>Resettable counter, counter will decrease.</i>	2			
<i>Nonresettable counter, counter will decrease.</i>	3			
<i>HASH PLU feature</i>	a	YES = 1	NO = 0	N 2 = a + b + c
<i>GALLONAGE PLU feature</i>	b	YES = 2	NO = 0	
<i>NON-ADD NUMBER compulsory</i>	c	YES = 4	NO = 0	
<i>PLU is NEGATIVE.</i>	a	YES = 1	NO = 0	N 3 = a + b + c
<i>PLU is SINGLE ITEM.</i>	b	YES = 2	NO = 0	
<i>VALIDATION compulsory</i>	c	YES = 4	NO = 0	
<i>PLU is PRESET.</i>	0			N 4
<i>PLU is OPEN (HALO).</i>	1			
<i>PLU is DISABLED.</i>	2			
<i>PLU is not taxable.</i>	0			N 5
<i>PLU is taxable by VAT 1.</i>	1			
<i>PLU is taxable by VAT 2.</i>	2			
<i>PLU is taxable by VAT 3.</i>	3			
<i>PLU is taxable by VAT 4.</i>	4			
<i>PLU is taxable by VAT 1 & 3.</i>	5			
<i>PLU is printed on KITCHEN PRINTER</i>	a	YES = 1	NO = 0	N 6

B. PROGRAMMING

A zero amount entry for open PLU will set the HALO (High Amount Lock Out) at the maximum seven digits (99999.99) for standard PLU, and five digits (99.999) for gallonage PLU.

Zero preset PLUs are allowed.

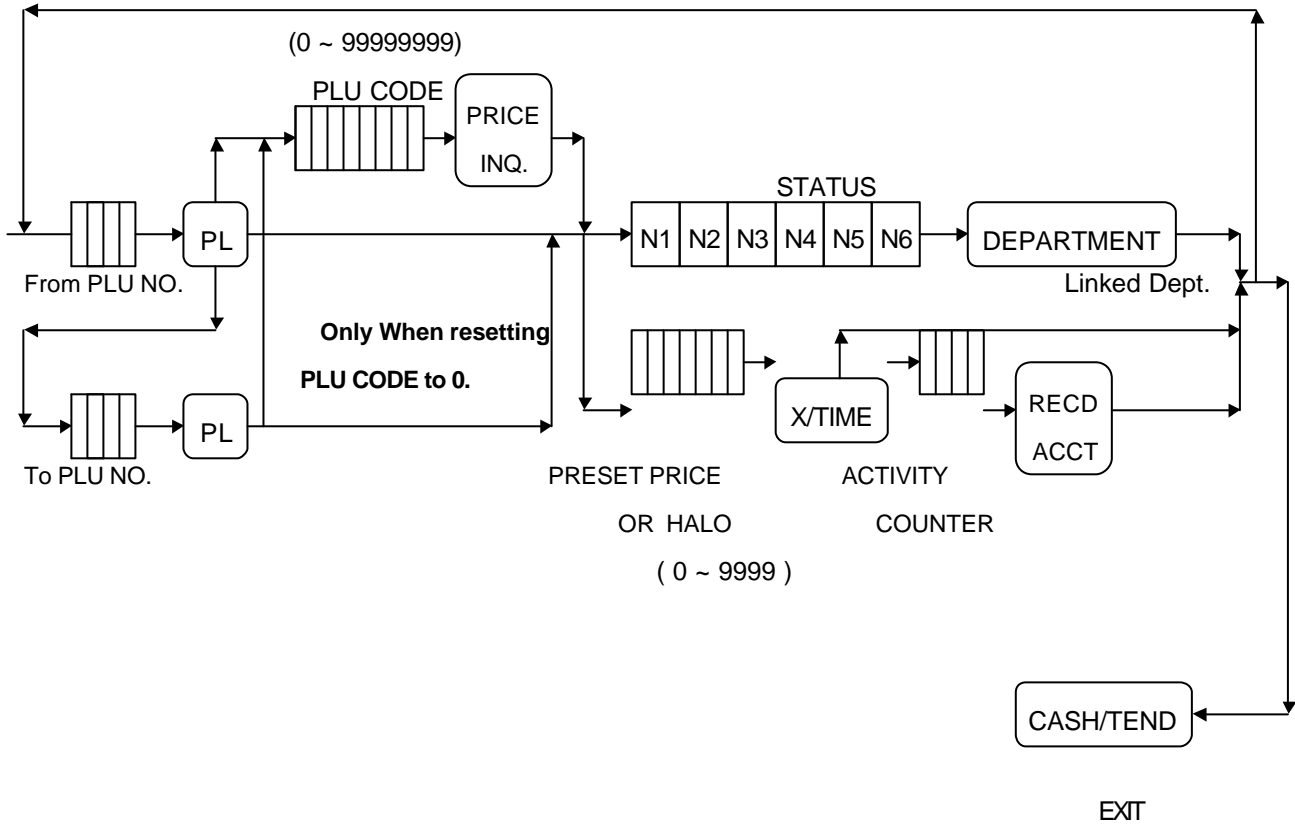

NOTE : From PLU NO. (1 ~ 1000) & To PLU NO. (1 ~ 1000)

2.9.2 PLU PROGRAMMING EXAMPLES

IMPORTANT : If PLU is not linked to department, PLU registration is not allowed.

EX 1) Program ' PLU 10' so it is VAT 1 and a KP item. It has a @99.99 HALO and linked to ' DEPT 1' .

Its code is ' 12345678' .

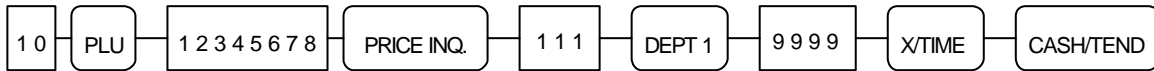

EX 2) Program ' PLU 20' so it is VAT 2 and a KP item. It has a PRESET price @10.00 and linked to ' DEPT 2' . Its code is ' 20010' .

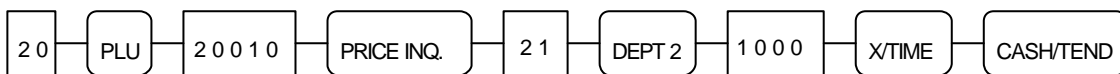

EX 3) Program ' PLU 30' so it is VAT 3, SINGLE ITEM and has a PRESET price @15.00 and linked to ' DEPT 3' . Its code is ' 313131' .

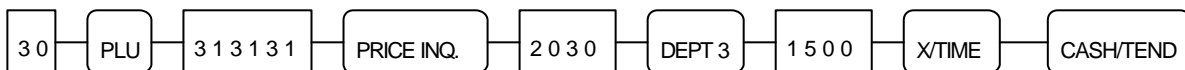

EX 4) Program ' PLU 40' so it is VAT 4 and a KP item. It has a PRESET price @1.00 and linked to ' DEPT 4' , initial activity counter is 100 with nonresettable, decreasing status.

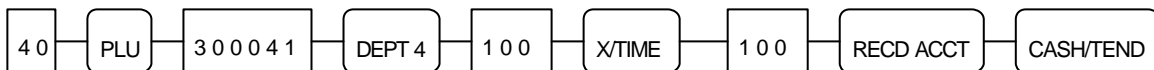

EX 5) Program ' PLU 50' so it is VAT 1 and a KP item. It has a PRESET price @10.00 and linked to ' DEPT 6' . Its code is ' 50100' .

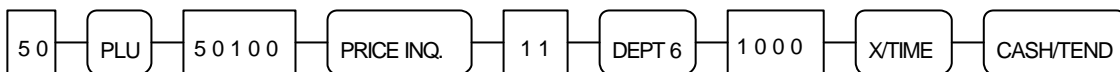

EX 6) Program ' PLU 1000' so it is VAT 1 and a KP item. It has a PRESET price @5.00 and linked to ' DEPT 6' .



EX 7) Link ' PLU 1000' to ' PLU 50' . (Refer to next page ' 2.9.4 PLU LINK PROGRAMMING')



2.9.3 PLU PROGRAMMING SCAN

- (1) Press the “ **CASH/TEND**” key.
- (2) Enter the **number of the first PLU** you want to scan, and press the “ **PLU**” key.
- (3) Enter the **number of the last PLU** you want to scan, and press the “ **PLU**” key.

NOTE : The first PLU number & The last PLU number

EX) To scan PLU 1 ~ 1000

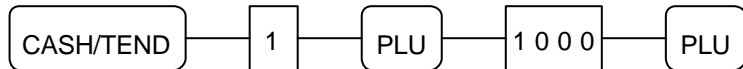

2.9.4 PLU LINK PROGRAMMING

This programming is used to **link two or more PLUs**.

The second PLU (B) will be automatically registered when the first PLU (A) is registered.

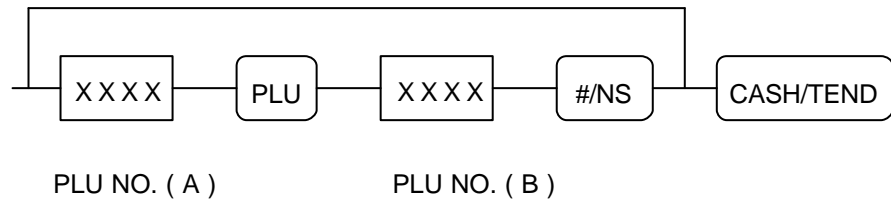

2.9.5 REMOVING OR DELETING A PLU

In order to " **de-activate** " a PLU, or " **remove** " its **status and linked department**.

Deleted or inactivated PLUs will not be allowed to register.

- (1) Enter the PLU number (1 ~ 1000), and press the "PLU" key.
- (2) Press the "VOID" key.

NOTE : PLUs with a total may not be removed (or deleted).

Issue the PLU report in " Z " mode before removing any PLU with a total.

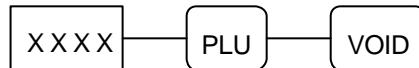

2.10 % KEY PROGRAMMING

This cash register has **two % keys**.

2.10.1 % KEY PROGRAMMING

A. PROGRAMMING STATUS

PROGRAMMING OPTION	VALUE		OPTION DIGIT
% key is <i>POSITIVE (SURCHARGE)</i> <i>NEGATIVE (DISCOUNT)</i> <i>OPEN</i> <i>PRESET</i>	a	1	N 1 = a + b
		0	
	b	2	
		0	
% key is <i>SALE</i> <i>ITEM</i> <i>AMOUNT</i> <i>PERCENTAGE</i> <i>INACTIVE</i> <i>ACTIVE</i>	a	1	N 2 = a + b + c
		0	
	b	2	
		0	
	c	4	
		0	

B. PROGRAMMING

- (1) Press the " %" key to be programmed.
- (2) Enter **the status** from the above table and press the " **SUBTL** " key.
- (3) Enter **the percentage or amount up to 5 digits** and press the " **CASH/TEND** " key.

Decimal point is fixed at three places.

EX) Percent Rate : 10 % would be 1 0 0 0 0

5.6 % would be 5 6 0 0

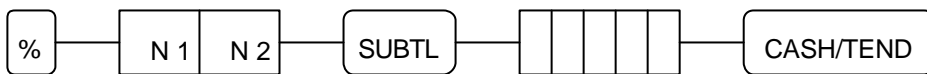

STATUS

5 DIGITS (Percent or Amount)

2.10.2 % CALCULATION ROUNDING FACTOR

Refer to **SYSTEM OPTION ADDRESS 38 (Page 26)**

2.11 CASH/TEND KEY PROGRAMMING



Tendering HALO (0 ~ 999999, 0 for no HALO)

2.12 CHEQUE KEY PROGRAMMING

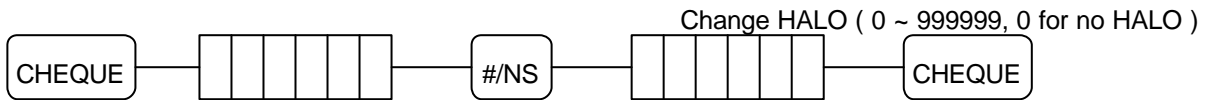

Tendering HALO (0 ~ 999999, 0 for no HALO)

2.13 CHARGE KEY PROGRAMMING

This cash register has **two charge keys**.



Tendering HALO (0 ~ 999999, 0 for no HALO)

2.14 PRESET CASH KEY PROGRAMMING



Desired amount (0 ~ 999999)

2.15 CASH IN DRAWER LIMIT PROGRAMMING

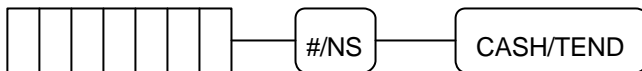

Total amount of cash allowed to be in the cash drawer at one time. (0 ~ 9999999)

NOTE : If the cash-in-drawer limit is exceeded, an error tone will sound.

The " CLEAR" key will stop the error tone.

2.16 CURRENCY CONVERSION KEY PROGRAMMING

This cash register has **two conversion key**.

The foreign exchange rate is determined on a six-digit code entered.

Numbers **N1 ~ N5** are the numeric **value of the exchange rate**, number **N6** sets the **decimal point position (0 ~ 5)**.

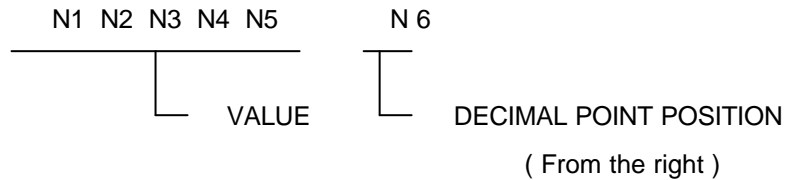

EX) £ 1.00 = 2.4455 DM

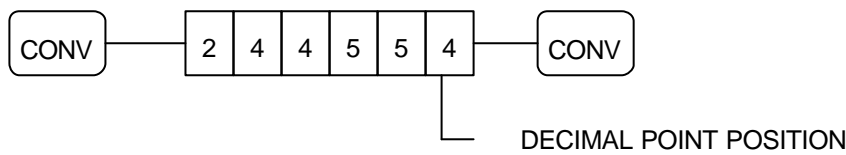

2.17 EUROPEAN ROUNDING PROGRAMMING

If you use the **European rounding**, after **programming the European rounding**, set the **SYSTEM OPTION ADDRESS 40 to 1.**(Page 26)

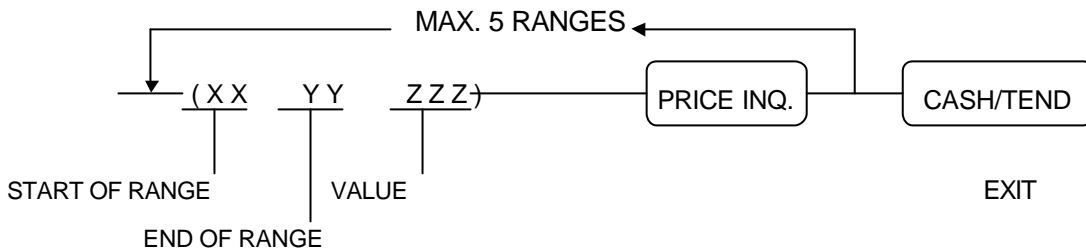

NOTE : The last end of range should be 9 or 99.

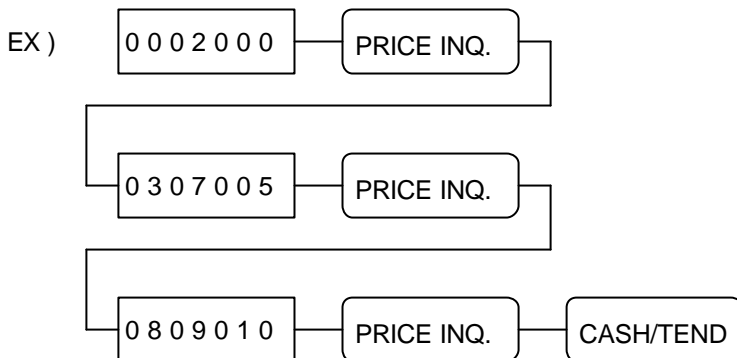

2.18 PARAMETERS PROGRAM SCAN

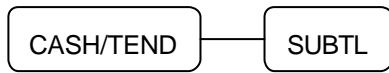

OPERATING NOTE

This section shows you **how to operate the cash register during normal use**.

The operating steps are explained with **flow chart boxes**.

Each box represents a key on the keyboard that you should press to complete an operation.

Unless the specified note, the flow charts use the " **CASH/TEND**" key to **finalize the sale**.

NOTE : A clerk must be signed on before operation takes place.

All registrations are made in the " REG" or " VOID" control lock position.

1 CLERK SIGN ON

1.1 IN CASE OF 4 CLERKS (SYSTEM OPTION 28' s VALUE ' C' = 0)

1.1.1 PUSH BUTTON SIGN ON



The clerk key (1, 2, 3 or 4) to start operation

1.1.2 SECRET CODE SIGN ON

To use this sign on method, SYSTEM OPTION ADDRESS 28 must be set to value ' b' .

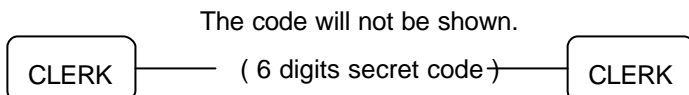

The clerk key (1, 2, 3 or 4) to start operation

1.2 IN CASE OF 15 CLERKS (SYSTEM OPTION 28' s VALUE ' C' = 4)

1.2.1 PUSH BUTTON SIGN ON

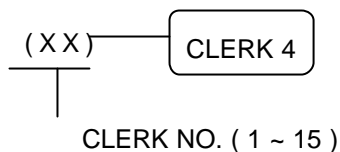

1.2.2 SECRET CODE SIGN ON

To use this sign on method, SYSTEM OPTION ADDRESS 28 must be set to value 'b'.

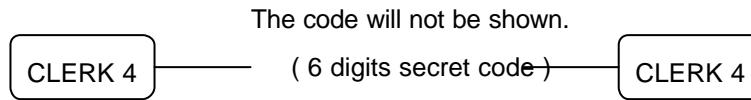

2 CLERK SIGN OFF

2.1 IN CASE OF 4 CLERKS (SYSTEM OPTION 28' s VALUE ' C' = 0)

CLERK When clerk sign off, the message " **CLOSEd**" displays **on the display**.

1, 2, 3 or 4

2.2 IN CASE OF 15 CLERKS (SYSTEM OPTION 28' s VALUE ' C' = 4)

CLERK 4 When clerk sign off, the message " **CLOSEd**" displays **on the display**.

3 REAL CLERK KEY ENTRY (Optional Device)

If you want to use **the real clerk keys**, you should set the **SYSTEM OPTION ADDRESS 53** to 1.

4 CLEARING AN ERROR CONDITION

If the error tone is ringing, press

CLEAR

There are several error symbols. Refer to ' DISPLAY SYMBOLS' (Page 15)

5 NO SALE OPERATION

A no sale operation is used to **open the cash drawer** outside of a sale.

#/NS

6 NON-ADD NUMBER ENTRIES

The " #/NS" key can be used to **enter up to eight digits**.

This numeric entry will be added to non-add number total.

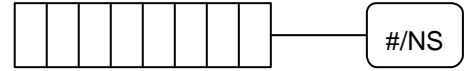

7 PRICE INQUIRY OPERATION

If you want to know the price (preset or HALO) of DEPT. or PLU during registration,

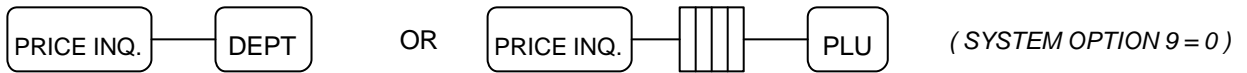

PLU NO. (1 ~ 1000)



PLU CODE (1 ~ 99999999)

8 DEPARTMENT ENTRIES

8.1 OPEN DEPARTMENT ENTRIES

(1) Single open DEPARTMENT entry

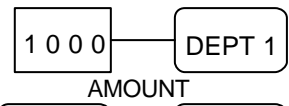

(2) Repeat open DEPARTMENT entry



(3) Multiple open DEPARTMENT entry

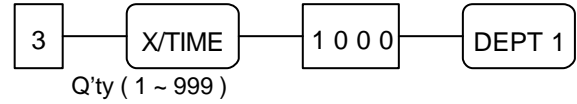

(4) Decimal multiplication
of open DEPARTMENT entry

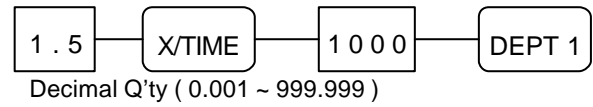

(5) Override HALO price entry

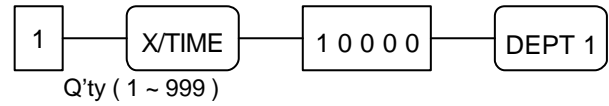

(6) Split pricing on open DEPARTMENT entry (Triple multiplication : SYSTEM OPTION 41 = 1)

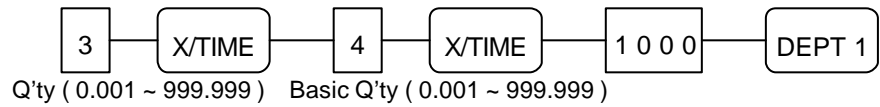

8.2 PRESET DEPARTMENT ENTRIES

(1) Single preset DEPARTMENT entry

DEPT 3

(2) Repeat preset DEPARTMENT entry

DEPT 3 — DEPT 3

(3) Multiple preset DEPARTMENT entry

3 — X/TIME — DEPT 3
Q'ty (1 ~ 999)

(4) Decimal multiplication
of preset DEPARTMENT entry

1 . 5 — X/TIME — DEPT 3
Decimal Q'ty (0.001 ~ 999.999)

(5) Override preset price entry

2 0 0 0 — DEPT 3

(6) Split pricing on preset DEPARTMENT entry (Triple multiplication : SYSTEM OPTION 41 = 1)

3 — X/TIME — 4 — X/TIME — DEPT 3
Q'ty (0.001 ~ 999.999) Basic Q'ty (0.001 ~ 999.999)

8.3 GALLONAGE DEPARTMENT OPERATION

NOTE : 1) Although gallonage departments are considered open departments, a price per gallon must be programmed on department programming. This price is calculated to three decimal points.

2) Although gallonage departments are programmed as a preset price, you must enter amount when gallonage department is registered.

* Same as gallonage PLU

EX) DEPARTMENT 10 has been programmed as gallonage department and unit price @1.399.

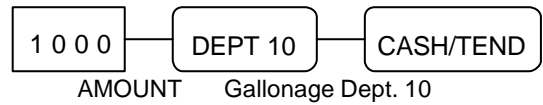

9 PLU (PRICE LOOK UP) ENTRIES

9.1 OPEN PLU ENTRIES

(1) Single open PLU entry

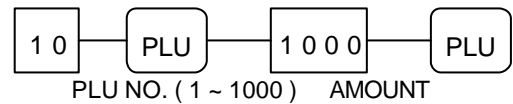

(2) Repeat open PLU entry

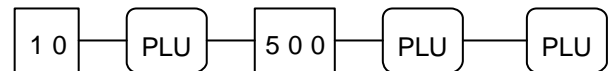

(3) Multiple open PLU entry

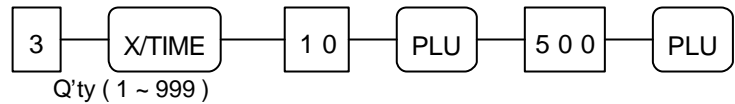

(4) Decimal multiplication of open PLU entry

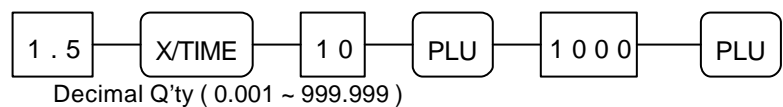

(5) Override HALO price entry

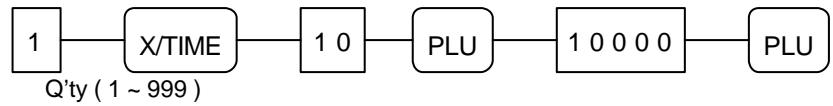

(6) Split pricing on open PLU entry (Triple multiplication : SYSTEM OPTION 41 = 1)

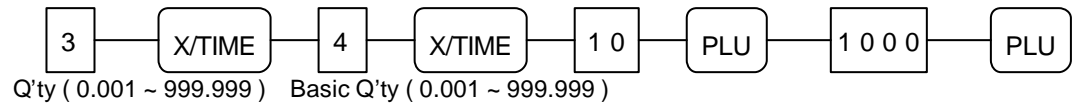

9.2 PRESET PLU ENTRIES

(1) Single preset PLU entry

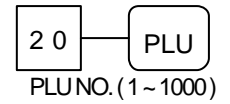

(2) Repeat preset PLU entry

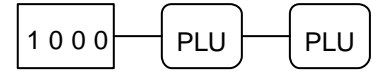

(3) Multiple preset PLU entry

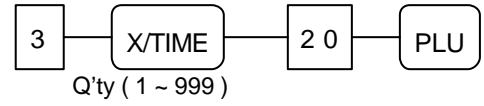

(4) Decimal multiplication of preset PLU entry



(5) Override preset price entry

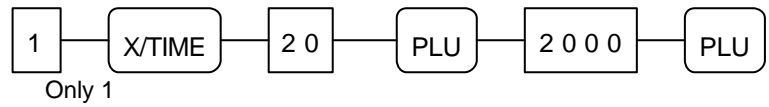

(6) Split pricing on preset PLU entry (Triple multiplication : SYSTEM OPTION 41 = 1)

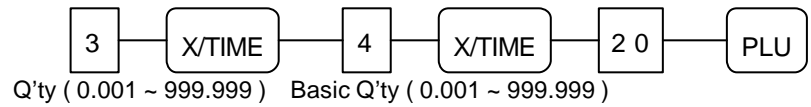

9.3 PLU TO PLU CHAIN OPERATION

All preset PLUs in the same chain (PLU to PLU linking) will be automatically registered when the first PLU of the chain is registered.

If a PLU located in the middle of the chain is registered, the following preset PLUs will be automatically registered.

EX) PLU 1000 is linked to PLU 50.

9.4 PLU ENTRIES BY CODE

This cash register can register PLU not only sequential index (1 ~ 1000) but also code up to 8 digits. If you want to register PLU by code, you must program PLU code on PLU programming and set SYSTEM OPTION ADDRESS 9 to 1.

NOTE : PLU entries by code is same to PLU entries by sequential index.

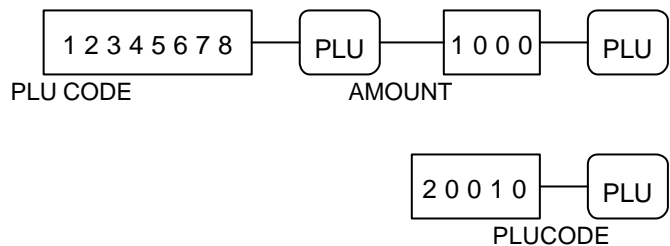

10 SINGLE ITEM DEPARTMENT OR PLU ENTRIES

Single item operation finalizes transaction without tendering key entry.

But the transaction is not finalized when you register another department or PLU before entering single item department or PLU.

10.1 SINGLE ITEM PRESET ENTRIES

DEPT 4

10.2 SINGLE ITEM OVERRIDE ENTRIES

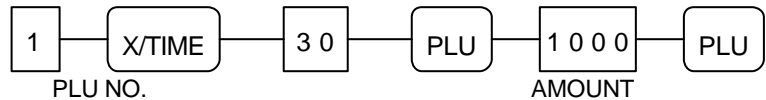

11 COMPUTATION OF VAT (Value Added Tax)

This cash register has **four taxes**.

NOTE : Refer to SYSTEM OPTION ADDRESS 4 to select inclusive or exclusive VAT.

11.1 INCLUSIVE VAT SYSTEM

(1) **Inclusive VAT** is used when a **tax amount** is already **included in the item price**, and a breakdown of the various tax charged is separated out.

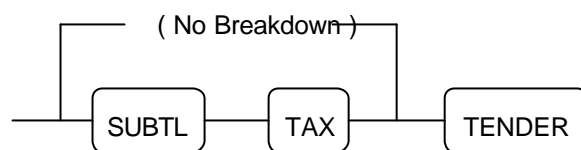

If you set **SYSTEM OPTION ADDRESS 3** to value ' c ' , **breakdown** will be **automatically done**.

(2) VAT SHIFT

when the " **TAX** " key is pressed before entering a **department or PLU programmed as VAT 1**, their tax status **shift VAT 1 to VAT 2**.

when the " **TAX** " key is pressed before entering a **department or PLU programmed as VAT 1&3**, their tax status **becomes VAT 1**, in that VAT 1 remains unchanged and VAT 3 is deleted.



11.2 EXCLUSIVE VAT SYSTEM

(1) **Exclusive VAT** is used when a **tax amount** is **not included in the item price**, and a tax amount is calculated by a tax rate.

(2) **TAX EXEMPT**

While the **exclusive VAT** system is in use, you can **exempt a taxable department or PLU from tax**.



* Inclusive VAT *

* Exclusive VAT *

12 % KEY ENTRIES

The **item discount or surcharge** is that discount or surcharge **is applied to one item**, while the **sale discount or surcharge** is that discount or surcharge **is applied to the entire sale**.

NOTE : If you want to sale discount or surcharge you must press the " SUBTL" key before entering the " %" key.

12.1 PERCENT RATE DISCOUNT / SURCHARGE

12.1.1 ITEM DISCOUNT / SURCHARGE

(1) Preset percent item discount / surcharge



(2) Override preset item discount / surcharge

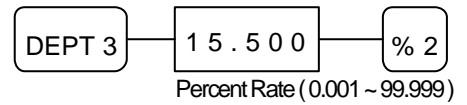

12.1.2 SALE DISCOUNT / SURCHARGE

(1) Preset percent sale discount / surcharge

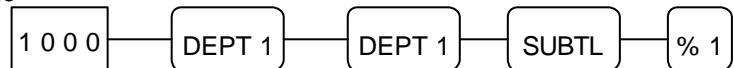

(2) Open sale discount / surcharge

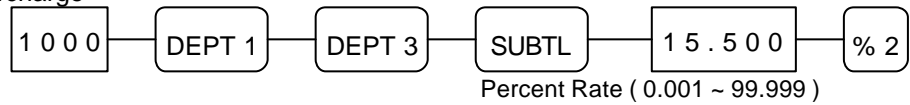

12.2 AMOUNT DISCOUNT / SURCHARGE

12.2.1 ITEM DISCOUNT / SURCHARGE

(1) Preset amount item discount / surcharge



(2) Override amount item discount / surcharge

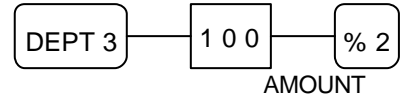

12.2.2 SALE DISCOUNT / SURCHARGE

(1) Preset amount sale discount / surcharge



(2) Open sale discount / surcharge

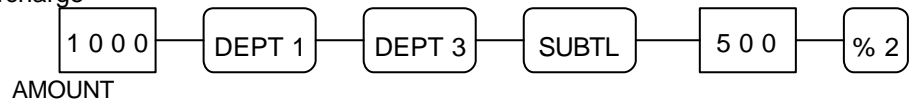

13 MERCHANDISE RETURN OPERATION

A. Merchandise return of a single department or PLU entry

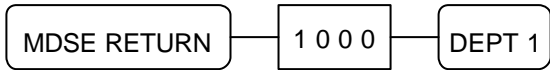

B. Merchandise return of multiple department or PLU entry

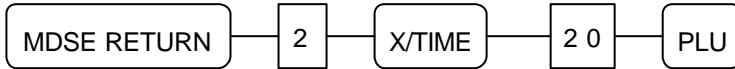

C. Merchandise return of the discounted / surcharged item

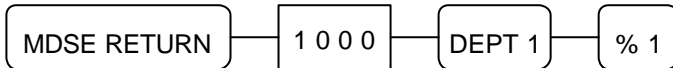

NOTE : Merchandise return of the negative department or PLU is not allowed, and void of merchandise return entry is not allowed.

14 VOID OPERATION

14.1 VOID OF A LAST ITEM ENTRY (ERROR CORRECT)

Press the " VOID" key immediately after making an incorrect entry.

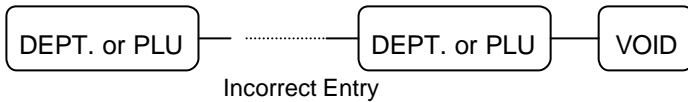

14.2 VOID OF A PREVIOUS ITEM ENTRY

You can correct using the " VOID" key at any point during the sale.



OR

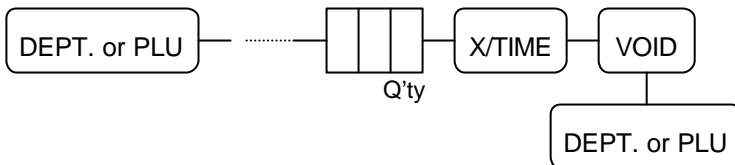

14.3 VOID OUTSIDE OF A SALE

If you want to void a number of items of incorrect entries that were **not made void during a sale.**

- (1) Turn the **control lock key** to the " **VOID**" **position.**
- (2) Make **all entries** that you want **to void** in the normal sequence.
- (3) All these items will appear **as alternative sign amount.**
- (4) All "VOID" position operations maintain their own total on the report.

14.4 CANCEL (VOID 4)

The pressing of the " **CANCEL**" key during a transaction **cancels the entire transaction.**

This is **not a tendering key !!**

Transactions **up to thirty items** may be canceled.

If a **cancel operation** is attempted after the entering of **more than thirty items, an error** will occur.

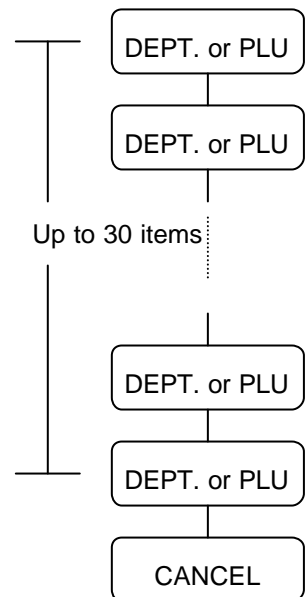

15 ADD CHECK OPERATION

Where multiple receipts are required for one purchase.

ie: For admissions where people require separate entrance tickets.

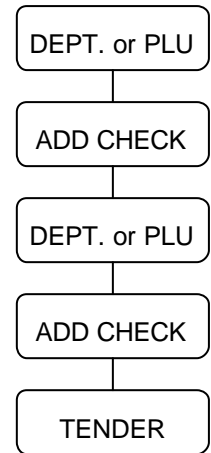

16 TENDERING OPERATION

16.1 CASH TENDERING

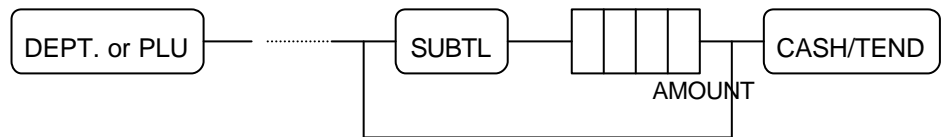

16.2 PRESET CASH TENDERING

You must **program the " PRESET CASH" key.**

If you don't program this key, an error will occur when you enter the "PRESET CASH" key.

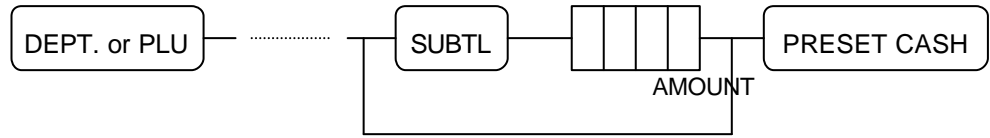

16.3 CHEQUE TENDERING

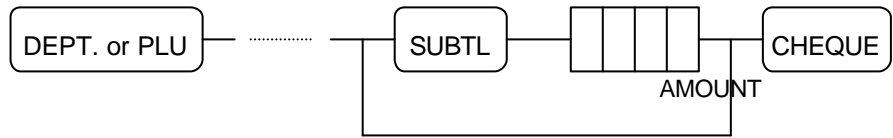

16.4 CHARGE TENDERING

The **entering amount** of charge must **not be more than subtotal amount**.

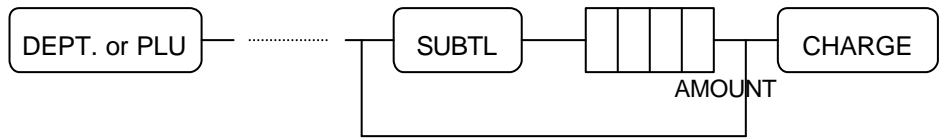

16.5 SPLIT TENDERING

You can tender **any combination of media**.

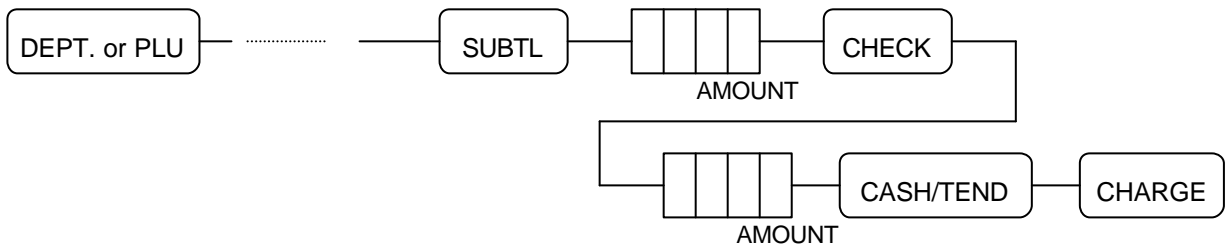

16.6 TENDERING WITH CURRENCY CONVERSION

You must program the " CONV " key.

If you don't program this key, an error will occur when you enter the "CONV" key.

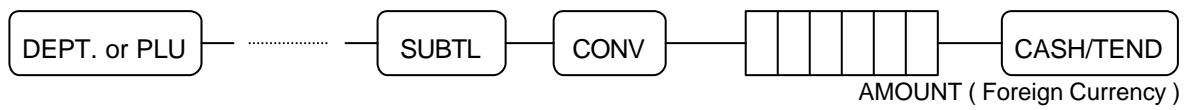

16.7 POST TENDERING

NOTE : If you want to use post tendering function, you must set SYSTEM OPTION ADDRESS 13 to 1 (Page 24).

Post tendering function is only allowed on cash transactions.

After post tendering, the display will show the remaining amount and the drawer will open.

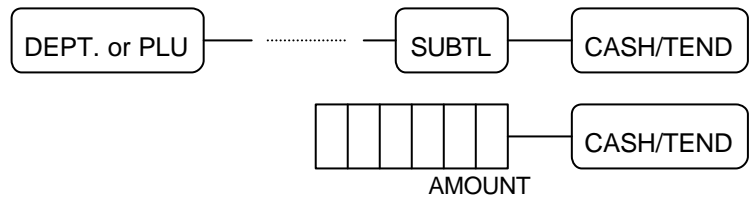

EX)

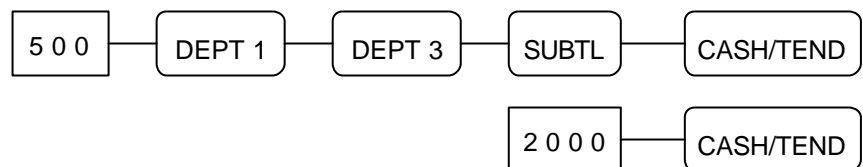

17 CHEQUE CASHING

If a customer wants to **cash a cheque**, use this function.

- (1) Enter *the amount of cheque*.
- (2) Press the “ **CHEQUE** ” key.

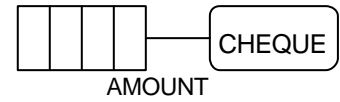

18 RECEIVED ON ACCOUNT OPERATION

A. Use the " RECD ACCT" key to register cash or cheque that is added to the cash drawer.

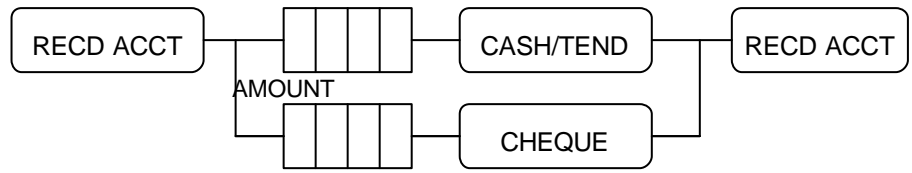

B. CHANGE BACK

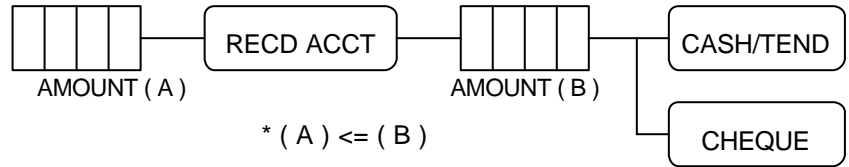

19 PAID OUT OPERATION

Use the " PAID OUT" key to register cash or cheque that is moved from the cash drawer.

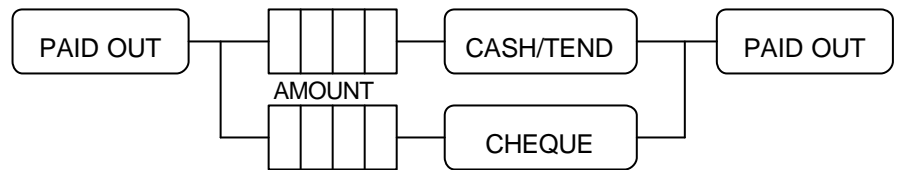

20 TABLE MANAGEMENT

This cash register can support the table management up to 50 lines.

(40 item lines + 10 tendering lines).

NOTE : If you want to use the table management, SYSTEM OPTION ADDRESS 46 must be 0.

20.1 TRANSACTION

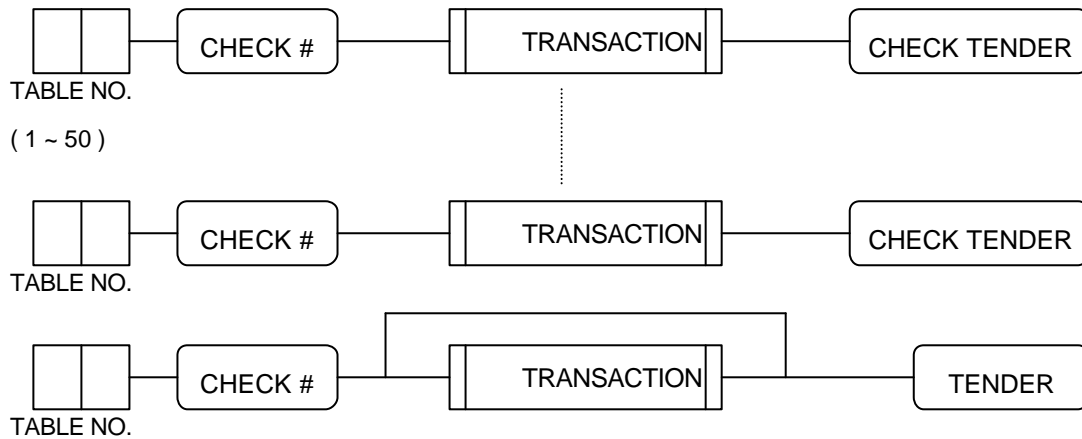

20.2 CONSOLIDATED RECEIPT PRINTING

If you want to issue the consolidated receipt about the table to be opened or tendered (by cash or cheque ...), press the table number and the " CHECK TENDER " key.

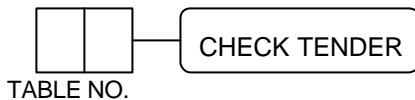

NOTE : If you set the SYSTEM OPTION 47 to 0, the consolidated receipt is only printed on the receipt of ECR.

If you set the SYSTEM OPTION 47 to 1, the consolidated receipt is printed on the receipt of ECR and the slip printer.

If you set the SYSTEM OPTION 47 to 2, the consolidated receipt is only printed on the slip printer.

NOTE : If you set the SYSTEM OPTION ADDRESS 48 to 0, when table management, the transaction will be printed on the slip printer.

(Refer to SYSTEM OPTION ADDRESS 54 (Page 27) to select the printer type.)

EX)

STEP 1

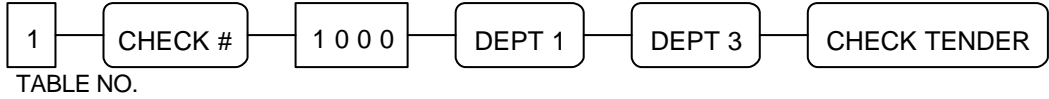

STEP 2

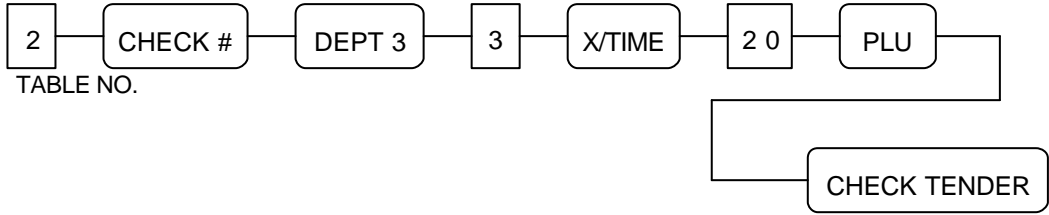

STEP 3

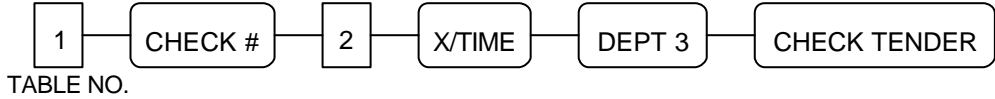

STEP 4

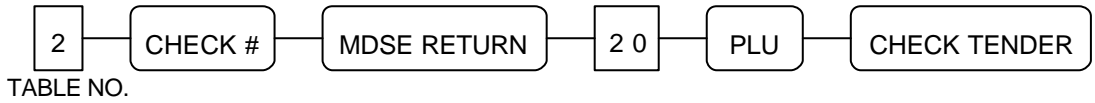

STEP 5

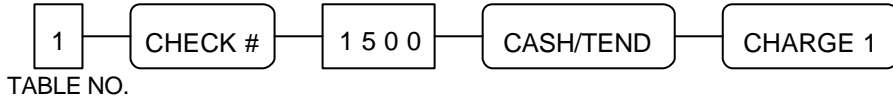

STEP 6



STEP 7

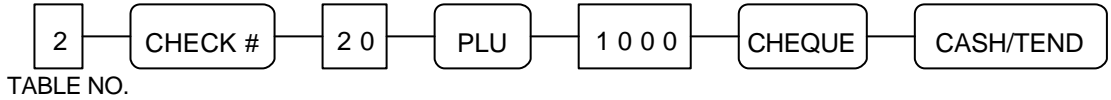

STEP 8

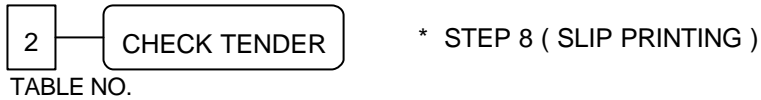

21 CASHIER OVERLAP

NOTE : If you want to use the cashier overlap, SYSTEM OPTION ADDRESS 46 must be 1.

If you set SYSTEM OPTION ADDRESS 29 to 1,

clerk change can be made without clerk sign-off operation.

21.1 TRANSACTION

CLERK X ! =>



CLERK CHANGE ! (CLERK X -> Y) ==>>

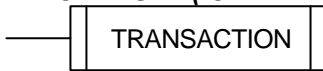

CLERK CHANGE ! (CLERK Y -> Z) ==>>

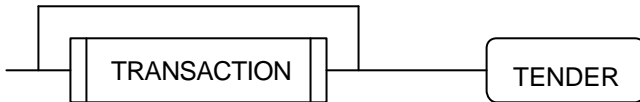

CLERK Z FINALIZES !

CLERK CHANGE ! (CLERK Z -> Y) ==>>

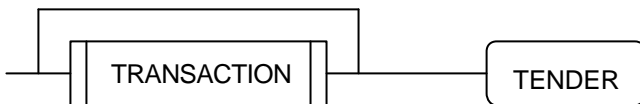

CLERK Y FINALIZES !

CLERK CHANGE ! (CLERK Y -> X) ==>>

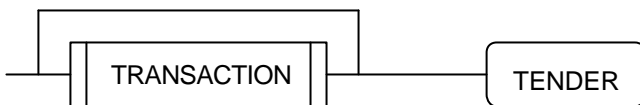

CLERK X FINALIZES !

21.2 CONSOLIDATED RECEIPT PRINTING

If you want to issue the consolidated receipt about the clerk to be opened or tendered (by cash or cheque ...), press the clerk number and the " CHECK TENDER" key.

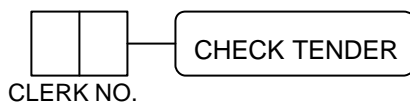

NOTE : If you set the SYSTEM OPTION 47 to 0, the consolidated receipt is only printed on the receipt of ECR.

If you set the SYSTEM OPTION 47 to 1, the consolidated receipt is printed on the receipt of ECR and the slip printer.

If you set the SYSTEM OPTION 47 to 2, the consolidated receipt is only printed on the slip printer.

NOTE : If you set the SYSTEM OPTION ADDRESS 48 to 0, when cashier overlap, the transaction will be printed on the slip printer.

(Refer to SYSTEM OPTION ADDRESS 54 (Page 27) to select the printer type.)

EX) Assume that clerk sign on method is push button type.

STEP 1 CLERK 1 ! =>



STEP 2 CLERK CHANGE ! (1 -> 2) ==>

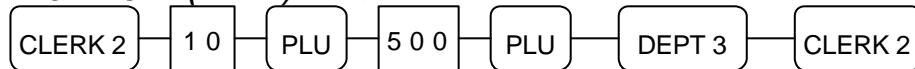

STEP 3 CLERK CHANGE ! (2 -> 1) ==>



CLERK 1 FINALIZES !

STEP 4

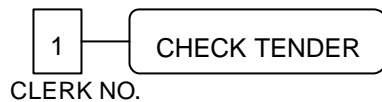

* STEP 4 (SLIP PRINTING) *

STEP 5 CLERK CHANGE ! (1 -> 2) ==>

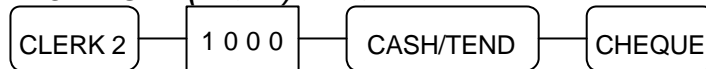

CLERK 2 FINALIZES !

STEP 6



* STEP 6 (SLIP PRINTING) *

22 PRINTING A BUFFERED RECEIPT OPERATION

If a customer requests a receipt after a sale has been finalized and the " RECEIPT ON/OFF" key was in the ' OFF' position during a sale, the press of the " RECEIPT" key will issue a buffered receipt.

(Up to 70 lines : 50 item lines + 20 tendering lines)

If more than 50 entries are made in the sale, the cash register will issue a stub receipt only, show the total net sale and correct the tax totals and payment tendered.

NOTE : The " RECEIPT ON/OFF" key must be used on " REG / VOID" position and can' t be used

during transactions.

Press the " RECEIPT ON/OFF" key once to change its status.

When the " RECEIPT ON/OFF" sign is illuminated on the display panel, the receipt printer will be turned off.

Refer to SYSTEM OPTION ADDRESS 21 (Page 24)

23 VALIDATION OPERATION

First of all, place a check or slip into the slot below the receipt / detail printer.

Upon pressing of the " VALID " key, validation will be performed on department and PLU entries,

RECD ACCT & PAID OUT operation, % key entries, merchandise return, voids and tendering operations.

If an operation is programmed as " Validation Compulsory " , the cash register will not operate until validation is completed and the message " S P " will appear on the display.

If any other operations are attempted before validation, an error will occur.

Refer to SYSTEM OPTION ADDRESS 20 (Page 24)

* SAMPLE VALIDATION RECEIPTS *

< RECEIPT SIDE > < JOURNAL SIDE >

01	251298	14:10	000068	RTN	APPLE	-10.00
a	b	c	d	e		f

01	122598	14:10	000068	DPT	DEPT.3	£10.00
a	b	c	d	e		f

* Date (b) = SYSTEM OPTION ADDRESS 25 = 1 (MM/DD/YY). (Page 25)

01	981225	14:10	000068	AMT	CASH	£10.00
a	b	c	d	e		f

* Date (b) = SYSTEM OPTION ADDRESS 25 = 2 (YY/MM/DD). (Page 25)

a = Clerk number.

b = Date.

c = Time.

d = Receipt consecutive number.

e = Registration step.

f = Validated transaction content.

24 RECEIPT MESSAGE PRINTING OPERATION

24.1 PREAMBLE MESSAGE

If you want to **print the receipt preamble messages** on the receipt, you must **program SYSTEM OPTION ADDRESS 43 (Page 26)** after **programming the preamble message descriptors**.

* SYSTEM OPTION 43 = 0 * * SYSTEM OPTION 43 = 1 * * SYSTEM OPTION 43 = 2 *

24.2 POSTAMBLE MESSAGE

If you want to **print the receipt postamble messages** on the receipt, you must **program SYSTEM OPTION ADDRESS 44 (Page 26)** after **programming the postamble message descriptors**.

25 TRAIN MODE

If you want to operate the **train mode**, you must program **SYSTEM OPTION ADDRESS 45**.

Refer to SYSTEM OPTION ADDRESS 45 (Page 26)

NOTE : All the amounts registered in the training mode are accumulated to the training mode report area and will not effect the normal report area.

The training mode reports are only daily reports and reset totals to ' 0' after issuing Z mode reports.

During the training mode, the journal paper will be not printed.

REPORT AND BALANCING

REPORT	REPORT NO.	REPORT TYPE	KEY LOCK	KEY SEQUENCE
FINANCIAL	1	X	X	1 SUBTL
		Z	Z	1 SUBTL
		X2	X	201 SUBTL
		Z2	Z	201 SUBTL
TIME	2	X	X	2 SUBTL
		Z	Z	2 SUBTL
		X2	X	202 SUBTL
		Z2	Z	202 SUBTL
PLU	3	X	X	3 SUBTL
		Z	Z	3 SUBTL
		X2	X	203 SUBTL
		X2	Z	203 SUBTL
IN-DRAWER	4	X	X	4 SUBTL
DAILY SALES	5	X2	X	205 SUBTL
		Z2	Z	205 SUBTL
OPEN TABLE (or OPEN CLERK)	6	X	X	6 SUBTL
INDIVIDUAL CLERK		X	X	SUBTL CLERK
		Z	Z	SUBTL CLERK
		X2	X	20 SUBTL CLERK
		Z2	Z	20 SUBTL CLERK
FROM/TO DEPT		X	X	FROM DEPT. KEY TO DEPT. KEY
FROM/TO PLU		X	X	FROM XXXX (PLU NO.) PLU TO XXXX (PLU NO.) PLU
DEPARTMENT	30	X	X	30 SUBTL
		Z	Z	30 SUBTL
		X2	X	230 SUBTL
		Z2	Z	230 SUBTL

NOTE : You can not issue the PLU report during training mode.

1 REPORT MODES

REPORT TYPE	TOTALS	Z Counter	REMARKS
X	Not reset	Not advance	
Z	Reset to '0'	Advance	
X2	Not reset	Not advance	Period-to-date report
Z2	Reset to '0'	Advance	Period-to-date report

**NOTE : If you don't want to open the drawer when the reports are run,
set SYSTEM OPTION ADDRESS 5 to value ' b' . (Page 23)**

2 CASH DECLARATION

If the compulsory cash declaration is programmed (SYSTEM OPTION ADDRESS 5), the cash declaration must be performed in " X / Z" mode prior to taking X / Z reports.

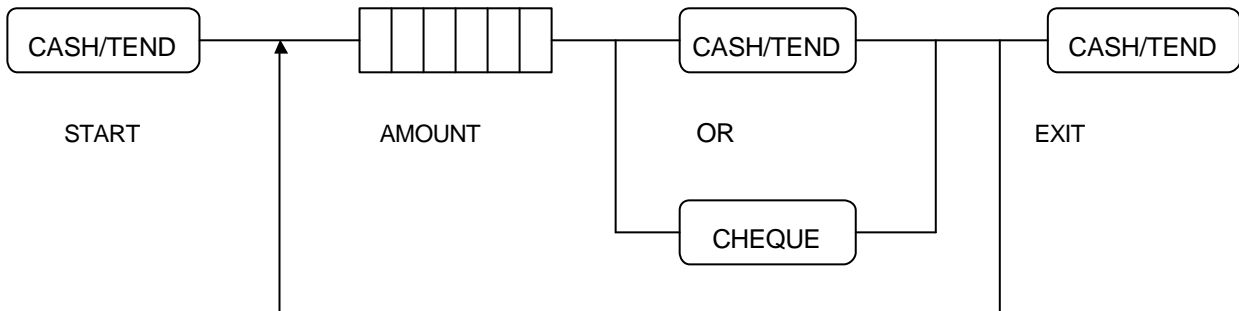

NOTE : After doing cash declaration in the ' X / Z' mode, if you turn the control key to any other position except the ' X / Z' , the cash declaration function will be lost.

So if you want to print the reports, you should perform the cash declaration again.

3 REPORTS

3.1 OPEN TABLE (or OPEN CLERK) REPORT

NOTE : If you operate table management (SYSTEM OPTION ADDRESS 46 = 0),
open table report will be issued,
while if you operate cashier overlap (SYSTEM OPTION ADDRESS 46 = 1),
open clerk report will be issued.

NOTE : If open table (or clerk) exists, the reports in ' Z' mode will not be issued and an error
tone will sound (' E9').
So if you want to issue the reports in ' Z' mode, you must finalize the open table
(or clerk).

A. X open table (or clerk) report (Key lock : 'X')

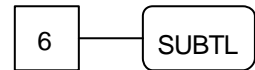

3.2 FINANCIAL REPORT

A. X financial report (Key lock : 'X')

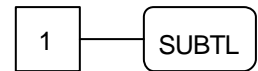

B. Z financial report (Key lock : 'Z')

C. X2 financial report (Key lock : 'X')

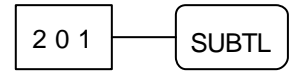

D. Z2 financial report (Key lock : 'Z')

3.3 TIME REPORT

A. X time report (Key lock : 'X')

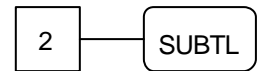

B. Z time report (Key lock : 'Z')

C. X2 time report (Key lock : 'X')

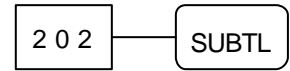

D. Z2 time report (Key lock : 'Z')

3.4 PLU REPORT

A. X PLU report (Key lock : 'X')

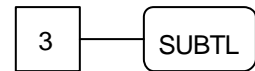

B. Z PLU report (Key lock : 'Z')

C. X2 PLU report (Key lock : 'X')

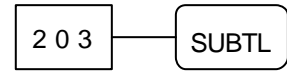

D. Z2 PLU report (Key lock : 'Z')

3.5 FROM / TO PLU REPORT

A. X from / to PLU report (Key lock : 'X')

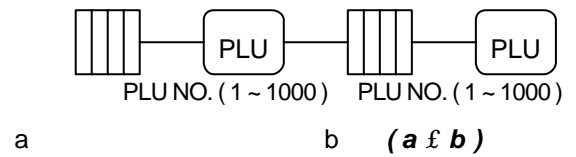

NOTE : If you press the " CASH/TEND" key during issuing the PLU or FROM/TO PLU report, the report will be finished after printing TOTAL COUNT and TOTAL AMOUNT.

3.6 IN-DRAWER REPORT

A. X in-drawer report (Key lock : 'X')

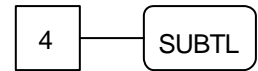

3.7 DAILY SALES REPORT

A. X2 daily sales report (Key lock : 'X')

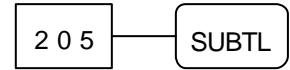

B. Z2 daily sales report (Key lock : 'Z')

3.8 INDIVIDUAL CLERK REPORT

3.8.1 IN CASE OF 4 CLERKS (SYSTEM OPTION 28' s VALUE ' C' = 0)

A. X individual clerk report (Key lock : 'X')

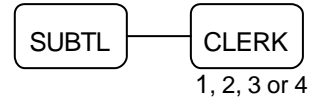

B. Z individual clerk report (Key lock : 'Z')

C. X2 individual clerk report (Key lock : 'X')

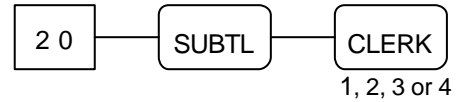

D. Z2 individual clerk report (Key lock : 'Z')

3.8.2 IN CASE OF 15 CLERKS (SYSTEM OPTION 28' s VALUE ' C' = 4)

A. X individual clerk report (Key lock : 'X')

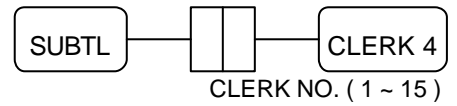

B. Z individual clerk report (Key lock : 'Z')

C. X2 individual clerk report (Key lock : 'X')

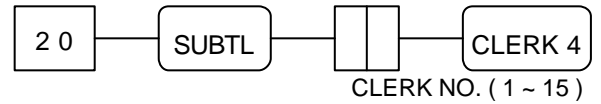

D. Z2 individual clerk report (Key lock : 'Z')

* OPTIONAL FULL CLERK REPORT (SYSTEM OPTION 8) *

3.9 FROM / TO DEPARTMENT REPORT

A. X from / to department report (Key lock : 'X')

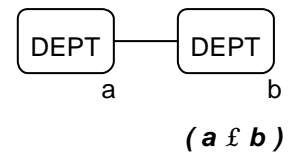

3.10 DEPARTMENT REPORT

A. X department report (Key lock : 'X')

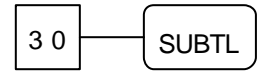

B. Z department report (Key lock : 'Z')

C. X2 department report (Key lock : 'X')

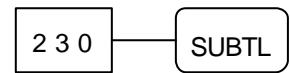

D. Z2 department report (Key lock : 'Z')

TROUBLE SHOOTING

Check the following items if the cash register does not work correctly !!

* Is the **power cord** plugged into the main socket correctly ?

* Is the **wall outlet** supplying power ?

Try plugging in another appliance.

* Is the **control lock** in the correct position ?

* Did you **change** the position of the **control lock during registration of the transaction** ?

If you set the control lock to another position while registration is in progress, an error will occur.

Return to the previous control lock position and press the correct keys to finalize the original transaction before changing the control lock setting.

MEMORY PROTECTION BATTERY

Totaled sales and other items are **protected during power failures** by a built in memory protection battery.

The **memory protection battery** is **charging** when the **power** is **on** and **discharging** when the **power** is **off**. This cause the capacity of the battery to decrease after about one year of use.

A label on the back of the cash register shows the normal service period of the battery installed in your cash register.

NOTE : A weak battery has the potential of losing valuable transaction data.

SPECIFICATION

POWER	AC 230 V , 50 Hz	
CABINET	ABS (V0)	
PRINTER	ERP-300V (2 STATION DOT-MATRIX PRINTER)	
DISPLAY	FRONT 10 DIGITS / REAR 10 DIGITS	
DRAWER	METAL (8 COINS / 4 BILLS)	
WEIGHT	15.0 Kg	
DIMENSION	SET = 374 (W) x 458 (D) x 195 (H)	DRAWER = 400 (W) x 450 (D) x 111 (H) (Including foot)
USAGE CONDITION	TEMPERATURE : 0°C ~ 40°C	HUMIDITY : 10 % ~ 90 %
NOISE	UNDER 70 dB	

APPENDIX

1 CHARACTER CODE TABLE

CHAR	á	à	â	ä	å	Ä	Å	é	è	ê
CODE	001	002	003	004	005	006	007	008	009	010
CHAR	ë	É	í	ì	î	ï	Í	ñ	Ñ	ó
CODE	011	012	013	014	015	016	017	018	019	020
CHAR	ò	ô	ö	Ö	ú	ù	ü	û	Ü	æ
CODE	021	022	023	024	025	026	027	028	029	030
CHAR	ß	SPACE	!	"	#	\$	%	&	'	(
CODE	031	032	033	034	035	036	037	038	039	040
CHAR)	*	+	,	-	.	/	0	1	2
CODE	041	042	043	044	045	046	047	048	049	050
CHAR	3	4	5	6	7	8	9	:	;	<
CODE	051	052	053	054	055	056	057	058	059	060
CHAR	=	>	?	@	A	B	C	D	E	F
CODE	061	062	063	064	065	066	067	068	069	070
CHAR	G	H	I	J	K	L	M	N	O	P
CODE	071	072	073	074	075	076	077	078	079	080
CHAR	Q	R	S	T	U	V	W	X	Y	Z
CODE	081	082	083	084	085	086	087	088	089	090
CHAR	Î	Pts	f	^	?	Ft	a	b	c	d
CODE	091	092	093	094	095	096	097	098	099	100
CHAR	e	f	g	h	i	j	k	l	m	n
CODE	101	102	103	104	105	106	107	108	109	110
CHAR	o	p	q	r	s	t	u	v	w	x
CODE	111	112	113	114	115	116	117	118	119	120
CHAR	y	z								
CODE	121	122								

2 ALPHA-NUMERIC KEYBOARD LAYOUT

2.1 ER-5115 ALPHA-NUMERIC KEYBOARD LAYOUT

RECEIPT FEED	DETAIL FEED			SPACE	ñ , f F	Ö 2 l l	æ 8 r R	# = w W	&= LEVEL 3 @ = LEVEL 2 z = LEVEL 1 7 = LEVEL 0
RECEIPT ON/OFF		CLEAR		BKSP	í + e F 5	ö 1 k K 10	Ü 7 q Q 15	" < v	% ? y Y
		7	8	9	ï * d D 4	ô 0 j J 9	û 6 p P 14	! ; u U	\$ > x X
		4	5	6	î) c C 3	ò / i I 8	ü 5 o O 13	SPACE : t T	LEVEL SHIFT
		1	2	3	ì (b B 2	ó . h H 7	ù 4 n N 12	ß 9 s S	
		0	00	.	í , a	Ñ - g G 6	ú 3 m M 11	DOUBLE	CASH/ TEND

2.2 ER-5140 ALPHA-NUMERIC KEYBOARD LAYOUT

RCPT FEED	DETL FEED	RCPT ON/OFF		Space						PAID OUT				
		CLEAR	Bksp	W / Å 5	Pt 4 É 10	a 9 í 15	f > ô 20	k C ü 25	p H Space	u M % 35	= LEVEL 2 = LEVEL 1 = LEVEL 0			
		7	8	9	V . Ä 4	Æ 3 è 9	Ft 8 ï 14	e = ò 19	j B ù 24	o G ß 29	t L \$ 34	y Q . 39		LEVEL SHIFT
		4	5	6	U - â 3	Z 2 è 8	? 7 î 13	d < ó 18	i A ú 23	n F æ 28	s K # 33	x P - 38		
		1	2	3	T , ä 2	Y 1 è 7	^ 6 ì 12	c ; Ñ 17	h @ Ö 22	m E Ü 27	r J " 32	w O ' 37	DOUBLE	
		0	00	.	S + â 1	X 0 é 6	f 5 í 11	b : ñ 16	g ? ö 21	l D û 26	q l ! 31	v N & 36	CASH/TEND	

3 COMMUNICATION INTERFACE

3.1 PIN DESCRIPTION FOR SERIAL INTERFACE

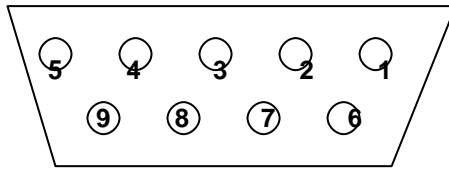

SERIAL PORT

SERIAL PORT	
PIN NO.	SIGNAL
1	Not connect
2	RXD
3	TXD
4	DTR
5	GND
6	Not connect
7	Not connect
8	Not connect
9	Not connect

3.2 CABLE SPECIFICATION

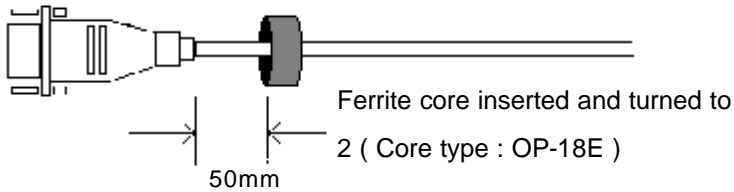

CABLE FOR SERIAL PORT

4 COMMUNICATION WITH PC

This cash register can **communicate with PC**.

The programming contents are downloaded from PC and uploaded to PC.

And the each report is uploaded to PC.

To communicate with PC,

(1) Turn the **control lock key** to the " **SERVICE MODE**" .

(2) Press the " **RECD ACCT**" key. The message " **--OnLinE--**" will be shown on the display.

NOTE : If you want to escape from " online" mode, press the " CLEAR" key.

It is advisable to always shut down 'WINDOWS' into 'DOS' before using the ER5100 Utility program.

5 PRINTING ON THE ROLL PRINTER

If you want to **print the sale items on the roll printer**, set the **SYSTEM OPTION ADDRESS 48** to 1.

And then, the sale items will be printed on the roll printer when tendering.

Refer to SYSTEM OPTION ADDRESS 54 (Page 27) to select the printer type.

NOTE : If the roll printer is disconnected, the contents will be printed on the receipt.

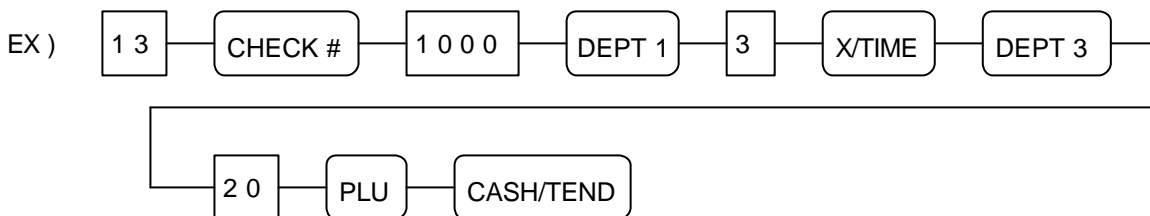

6 SCALE

If you want to operate the **scale**, set the **SYSTEM OPTION ADDRESS 42** to **1**.

And then you can use the "PRICE INQ." key as the "SCALE" key.

6.1 DIRECT SCALE ENTRY

When product is placed on the scale and the "SCALE" key is pressed, the weight will be appear on the display.

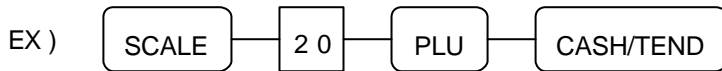

6.2 MANUAL WEIGHT ENTRY

If you want to make **manual weight entries**, set the **SYSTEM OPTION ADDRESS 42**' s value ' **b** ' .

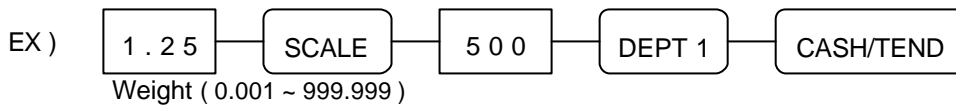

WIRING SPECIFICATION FOR PC & PRINTER

Samsung ER-5100 to Personnel Computer.

ECR		Computer
9 pin (male)		9 pin (female) 25 pin female
RXD 2	TXD 3.....	TXD 2
TXD 3	RXD 2.....	RXD 3
GND 5.....	GND 5.....	GND 7

Samsung ER-5100 to Kitchen/Slip Printer

ECR		Printer
9 pin (male)		25 pin (male)
RXD 2.....	TXD 2	
TXD 3.....	RXD 3	
DTR 4.....	DSR 6	
GND 5.....	GND 7	
DSR 8.....	DTR 20	