

The logo for 'e lite' features a stylized gear with a lowercase 'e' inside it, followed by the word 'lite' in a clean, sans-serif font.



The logo for the elite CR-101, featuring a gear with an 'e' inside, followed by the text 'elite CR-101' in a bold, sans-serif font, and 'electronic cash register' in a smaller, lowercase font below it.

Contents

STARTING UP	5
INTENDED USE	5
GENERAL INFORMATION / SAFETY NOTES	5
TRANSPORT PROTECTION LOCKS	5
CONNECTION TO THE POWER SUPPLY	5
PRINTER.....	6
INSERT PAPER ROLL.....	6
PAPER REEL.....	7
CHANGE INK ROLLER.....	7
MACHINE VIEW.....	8
DISPLAY	9
KEY-OPERATED SWITCH.....	10
KEYPAD.....	11
CR 101 KEYPAD.....	11
KEY FUNCTIONS.....	11
OPERATIONS.....	13
REGISTRATIONS.....	13
DEPARTMENT REGISTRATION (PRICED)	13
DEPARTMENT PRICE OVERRIDE.....	14
REPEATED DEPARTMENT REGISTRATION	14
REGISTRATION BY MULTIPLICATION.....	15
CHANGE COMPUTATION.....	16
REGISTRATION OF DIFFERENT PAYMENT TYPES	17
SPLIT (PARTIAL) PAYMENT	18
PREMIUM AND DISCOUNT	19
PREMIUMS - AS A PERCENTAGE	19
DISCOUNTS - AS A PERCENTAGE.....	20
DISCOUNTS - MANUALLY ENTERED AMOUNTS	20
CORRECTIONS.....	21
ERR CORRECT.....	21
VOID (DESIGNATED CANCELLATION)	21
REFUND/RETURNED MERCHANDISE.....	22
PAYMENTS RECEIVED ON ACCOUNT / PAID OUT.....	23
RECEIVED ON ACCOUNT	23
PAID OUT.....	23
MISCELLANEOUS REGISTER OPERATIONS	24
RECEIPT DUPLICATION	24
OPEN CASH REGISTER ELECTRONICALLY	24
OPEN CASH DRAWER MANUALLY	24
TIME DISPLAY	24

CALCULATOR OPERATION	24
ADDITION	25
SUBTRACTION.....	25
MULTIPLICATION	26
DIVISION	26
REPORTS	27
PASSWORD	27
X-REPORTS (WITHOUT MEMORY DELETION)	27
Z-REPORTS (WITH MEMORY DELETION).....	28
ABBREVIATIONS.....	28
SAMPLE REPORT.....	29
PROGRAMMING	30
GENERAL INFORMATION	30
RESTORE FACTORY DEFAULTS	30
REMOVE RUNNING TOTALS.....	30
PRINTING ALL PROGRAMMED SETTINGS (FLAGS)	31
PROGRAMMING THE BASIC PROGRAM.....	32
MODIFYING A SINGLE FLAG	32
FLAG TABLE	33
PROGRAMMING TAX.....	34
PROGRAMMING DEPARTMENTS.....	35
DEFINE THE ASSIGNMENT	35
PROGRAMMING BEFORE EURO CURRENCY CONVERSION.....	37
PROGRAMMING AFTER EURO CURRENCY CONVERSION	39
PROGRAMMING NON EURO CURRENCY CONVERSION	41
ERROR MESSAGES	43
OPTIONS AND MAINTENANCE	44
OPTIONS	44
SELF TESTS.....	42
SPECIFICATIONS	45

Starting Up

■ INTENDED USE

This cash register should only be used for performing cash register business indoors. Any other use is considered unintended use.

■ GENERAL INFORMATION / SAFETY NOTES

- Make sure that the mains voltage corresponds to the specifications indicated on the rating plate located at the back of the cash register.
- The cash register is a highly sophisticated piece of equipment. Never try to repair it yourself. If repairs are necessary, contact an authorized service centre or your sales outlet.
- Never insert metallic objects such as screwdrivers, paper clips, etc. into the cash register. They may damage the cash register and present the danger of causing an electric shock.
- Always switch off the cash register after finishing your work.
- Clean the cash register by dusting it with a dry cloth. Never use water or solvents, such as paint thinner / alcohol, to clean the cash register.
- In order to completely disconnect the cash register from the power supply, disconnect the power plug from the socket.
- Do not expose the cash register to excessive heat.
- Keep the transport protection locks for future use. If the cash register is subsequently moved, the transport lock must be reinstalled.

■ TRANSPORT PROTECTION LOCKS

Before starting to operate the cash register, remove any transport protection locks and keep them for the future

Important transport notes:

In the case of damage caused during transport, the unit must be returned with the packaging, operating instructions and accessories.

■ CONNECTION TO THE POWER SUPPLY

Before connecting the cash register to the mains power supply, check that the voltage and frequency specifications on the rating plate correspond to the local power supply.

Safety note:

The power sockets must be located close to the cash register and be easily accessible. This enables the cash register to be disconnected from the power supply quickly in an emergency.

Note:

All data is retained following disconnection from the mains power supply. The internal backup battery ensures data retention for approx. 1 year. To charge up the battery for this, keep the cash register connected to the power supply for 12 hours after switching it on for the first time.

■ PRINTER

Caution:

Observe the following information to ensure long, trouble-free operation:

Never:

- print without paper in the printer.
- pull the paper when the printer is in operation.
- use poor quality paper or ink rollers.
- re-use paper rolls a second time.
- manipulate the printer mechanism with hard objects or move by hand.

Always:

- Pay attention to the end of paper markings. Change the paper roll immediately.
- Have the cash register/printer serviced regularly by an authorized service centre.
- Change the ink roller when the print quality starts to deteriorate.

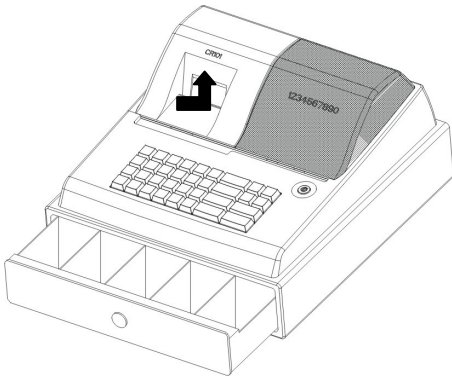

- Open the printer lid.
- Turn the key-operated switch to **R**.

■ INSERT PAPER ROLL

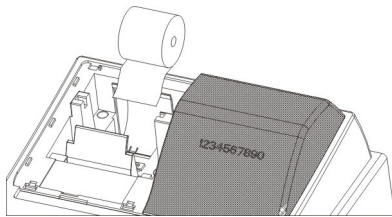

- Insert the paper roll (57 mm width) for the receipt in the paper holder. Bend the roll support a little to the left. The end of the paper roll must be at the bottom.

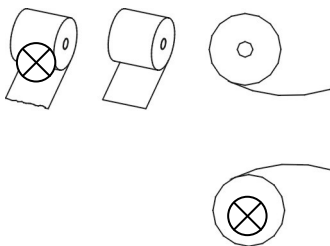

- Feed the end of the paper, (cut straight) in the printer and press [**FEED**] key. Depending on the method of use, (i.e. journal or receipt), feed the paper past the tear-off edge on the paper lid or onto the paper take-up reel.
- Close the printer lid

■ PAPER REEL

The Paper reel is required when you want a record of the transactions. If you wish to use the paper reel as opposed to receipt, it is necessary to program the machine for journal printing. Please refer to the programming section flag 01.

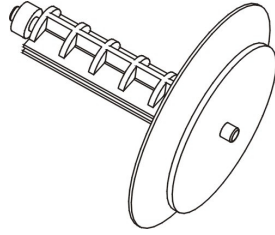

- Open the printer lid.
- Remove the paper reel.
- Thread the end of the paper in the slit in the paper reel.
- Insert the paper reel in the hollow provided.
- Close the printer lid.

- In order to remove the journal paper after it has been rolled up on the reel, remove the paper reel and pull the journal paper roll off
- Re-insert the paper reel

■ CHANGE INK ROLLER

Note:

Only use original ink rollers.

- Open the printer lid

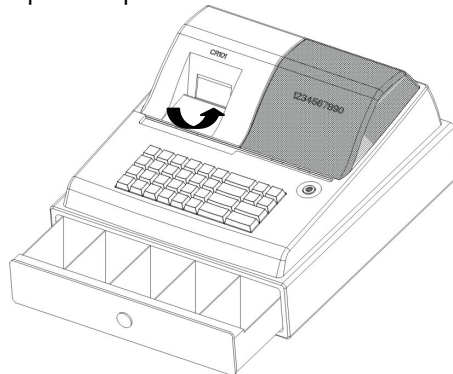

- Pull the ink roller up and out using the grip (on the left).

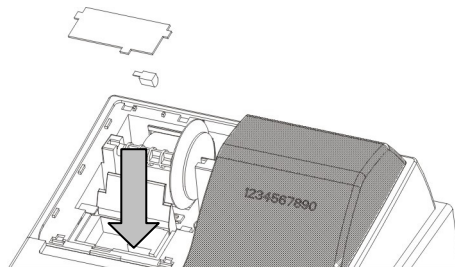

- Insert new ink roller on the guides.
- Close the printer lid.

Machine View

The diagram below illustrates the cash register with all its functional parts.

1. Printer lid
2. Paper reel
3. Operator Display
4. Key-operated switch
5. Keypad
6. Cash drawer
7. Printer cover
8. Ink roller

The diagram below illustrates the cash register with all its functional parts.

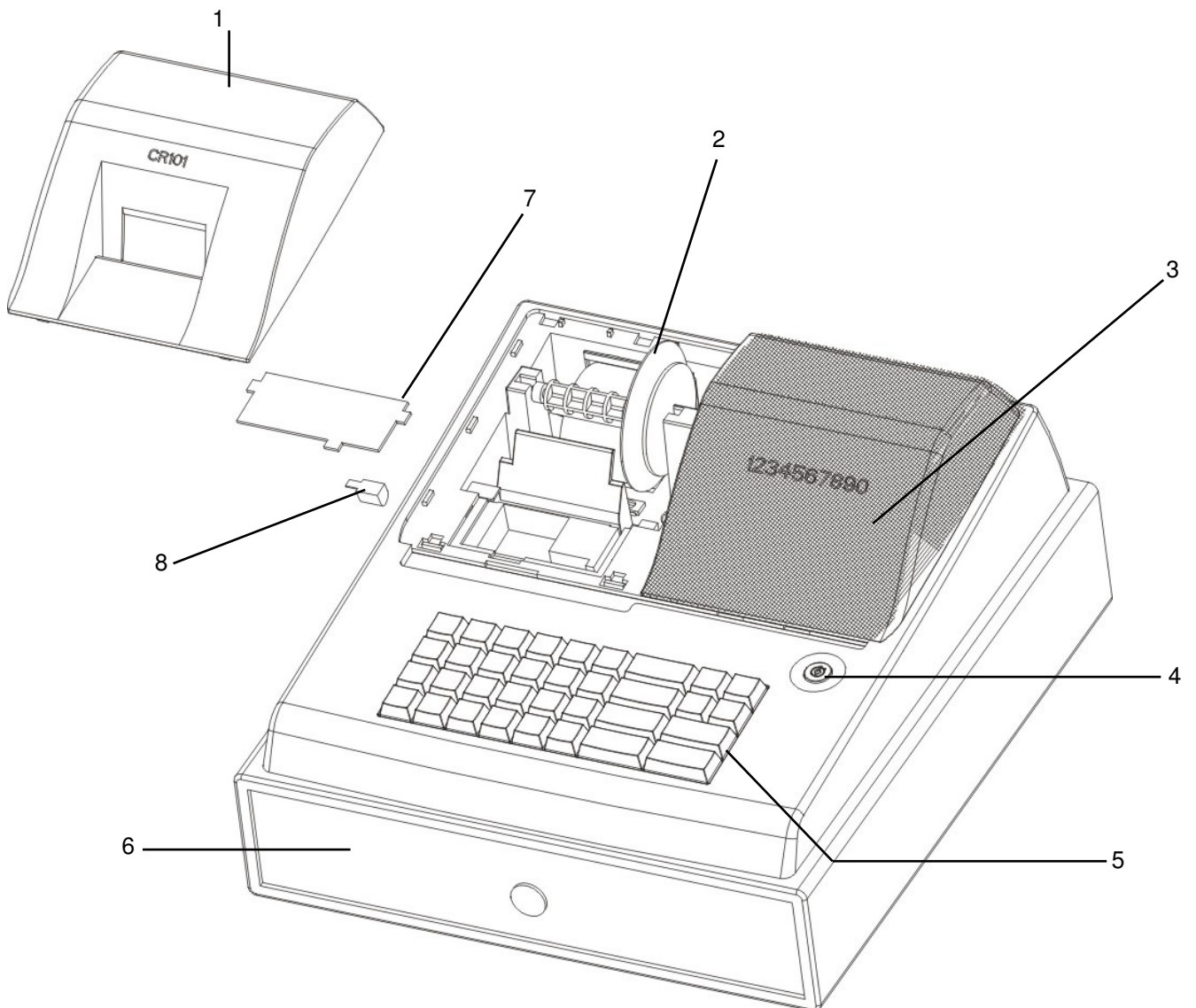

■ DISPLAY

The respective amount appears flush to the right in the display, to the left is the number of repetitions in cases where several registrations are made for one department.

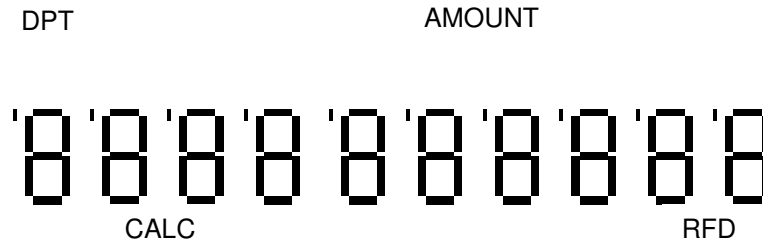

The upper part of the display indicates the following by means of illuminating marks:

DPT	Currently active department
CALC	Calculator mode
RFD	Refunds

Displays

In Positions "R"

tot	Total amount
Sub	Subtotal
**	Department number

In Position 'P'

ProG	Programming mode	BUzzEr	Buzzer tone test
**P	Department price	drA	Cash drawer test
**F	Department flag	kEyLoCk	Key-operated switch test
FCE*	Exchange rate	diSPLAY	Display test
dot	Currency flag	Pr intEr	Printer test
CL	Reset		

Position "X" and "Z"

rEAd	Print X reports	rESEt	Print Z reset reports
CA	Total amount in cash	E	Error
rAtE*	Tax Rate (1-4)	bASE *	Basic tax rate (1-4)

Key-Operated Switch

The key-operated switch is the operational centre of the cash register, allowing access to each of the key controlled positions. For such operations as registration, reporting and programming, each of which are detailed below.

Various keys are available which enable the different functions to be used.

The **OP** key enables the user to make registrations and print reports without clearing the memory.

The **OW** key enables the user to make registrations and print reports with or without clearing the memory. This key also allows access to the program mode of the cash register.

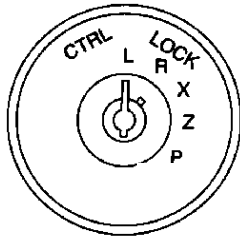

Significance of the switch positions:

- L** = Power supply is switched off.
Each key can be turned to this position.
- R** = This will display the time when initially turned to this position.
Press CLEAR to remove the time display.
Sales transactions can be registered (refer to Chapter "Operation")
Each key can be turned to this position.
- X** = **rEAD** is shown on the display when this mode is selected
Reports can be printed without deleting the memory contents
(refer to Chapter "Reports").
Each key can be turned to this position.
- Z** = **rESEt** is shown on the display when this mode is selected
Reports can be printed with memory contents deletion (refer to
Chapter "Reports").
The **OW** key is required for this position
- P** = **ProG** is shown on the display when this mode is selected
This mode is used to program the system flags, departments, items, prices, etc.
The **OW** key is required for this position

Note Turning of the mode key mid operation will result in an error tone. Return to the original position press CLEAR then finalise the current operation before turning the mode lock key.

Keypad

The keypad of cash register CR 101 is illustrated below. The functions of the keys are also described.

■ CR 101 KEYPAD

FEED	RA/ CALC	PO	7	8	9	DEPT 4 ÷	RCPT	€ EURO
VOID	RF	-	4	5	6	DEPT 3 X	CHEQ	CARD
ERR CORR	+%	-%	1	2	3	DEPT 2 -	SUB TOTAL	
CLEAR	X TIME	NS #	0	00	.	DEPT1 +	CASH =	

■ KEY FUNCTIONS

A short description of the keys is provided below:

Keyboard Operation

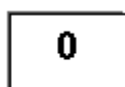

TO

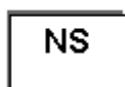
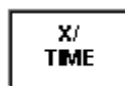
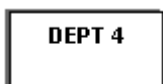
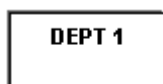
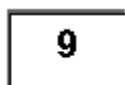

Description

Numerical Keys

- Enter prices, amounts, programming, etc
- Note** the decimal point is not required during normal operation.

Department keys

- Record items sold or returned in the department totals
- Register the fixed price of items
- Register the same item several times
- Calculation methods i.e. (+ - x %) in calculator mode.

Refund key

- Register the refunding of a department sale

Time/Date and multiplication

- Multiply the amount shown in the display
- Display current time and date
- Print financial report (key-operated switch position:X)

No sale key

- Numbers entered are not registered as amounts but printed as numerical entries.
(Used for example, to enter a customer account number)
- Open drawer to give change
- Used in the p-mode from program acceptance

Keyboard Operation

CASH

CHEQ

CARD

SUB
TOTAL

PO

RA/
CALC

-

VOID

+%

-%

FEED

CLEAR

€
EURO

RCPT

ERR
CORR

Description

Cash key

- Register cash payments, given amount is subtracted from the total payment due
- Total amount appears in the display, the cash drawer opens
- Change amount appears in the display
- Print full-report (key operated switch position:X)
- Print and delete full reports (key operated switch position:Z)
- Acts as equals in calculator mode

Credit- card/Cheque keys

- Register payments made via credit-card cheque, given amount is subtracted from the total payment due
- Total amount appear in the display, the cash drawer opens
- Change amount appears in the display

Subtotal key

- Display the subtotal

Paid Out key (PO)

- Register amounts paid out from the cash drawer

Received on account (RA)

- Register amounts paid into the cash drawer
- Start / end calculator mode

Minus Key

- Manual subtraction of the amount entered for the last item or the overall sale following subtotal (which can be programmed into the equation).

Void Key

- Cancel an amount that was registered several transactions before

Premium key

- Add a stored or manually entered percentage to the price of the last item or subtotal

Discount key

- Subtracts a stored or manually entered percentage to the price of the last item or subtotal

Receipt paper feed key

- Feed receipt paper without printing

Clear Key

- Deletes incorrect entries
- Clears errors

Foreign currency exchange key

- Enables conversion of various currencies

Receipt Key

- Receipt duplicate
- Issue receipt after sale when the receipt is turned off

Error Correct key

- Cancel the last amount registered

Operations

■ REGISTRATIONS

The cash register provides easy to use repeat and multiplying functions to simplify Operations.

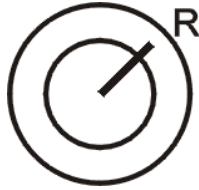

Key position: Registration.
All the following types of registration can be carried out with the key in this position.

■ DEPARTMENT REGISTRATION (PRICED)

Use the department keys to register programmed prices.

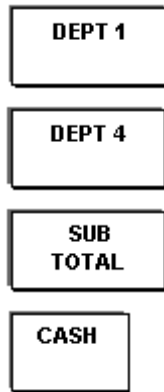

Press the required department key

Press the required department

Press the SUBTOTAL key to display the total due.

Press the relevant method of payment key

Example printout

	14-04-2001	Date
	09-21 0017	Time, Receipt no.
.01	10.00*	Dept. 1 fixed price, including tax
.04	20.00*	Dept. 4 fixed price, including tax
	1.38TX	Amount of tax 1 included
1	8.62 TA	Amount taxed
	1.31TX	Amount of tax 2 included
2	18.69 TA	Amount taxed
	30.0ST	Subtotal of registration
	30.00CA	Cash payment

* The printing of TAX information is optional. (see programming options)

■ DEPARTMENT PRICE OVERRIDE

It is possible to manually enter a price which differs from the price programmed for a Department (Price Override). The programmed department price remains unchanged.

Note It is not Necessary to use the decimal point key during normal operations.

0	TO	9	Enter the amount
DEPT 1			Press the required department key
0	TO	9	Enter the amount
DEPT 4			Press the required department key
SUB TOTAL			Press the SUBTOTAL key to display the total due.
CASH			Press the relevant tender key

Example printout

.01	14-04-2001	Date	14-04-2001
.04	09-25 0018	Time, Receipt no.	09-25 0018
	100.00*	Dept. 01 registered price, including tax	100.00*
	200.00*	Dept. 04 registered price, including tax	200.00*
	13.79TX1	Amount of tax 1 included	13.79TX1
	86.21 TA	Amount taxed	86.21 TA
	13.08TX2	Amount of tax 2 included	13.08TX2
	186.92 TA	Amount taxed	186.92 TA
	300.00ST	Subtotal of registration	300.00ST
	300.00CA	Cash payment	300.00CA

* The printing of TAX information is optional. (see programming options)

■ REPEATED DEPARTMENT REGISTRATION

Repetition of registration can be performed after entering amounts.

0	TO	9	Enter the amount
DEPT 1			Press the required department key
DEPT 1			Press the required department key
SUB TOTAL			Press the SUBTOTAL key to display the total due.
CASH			Press the relevant tender key

■ REGISTRATION BY MULTIPLICATION

The multiplication of registrations can be performed after entering amounts. (Only use whole numbers as the multiplication factor).

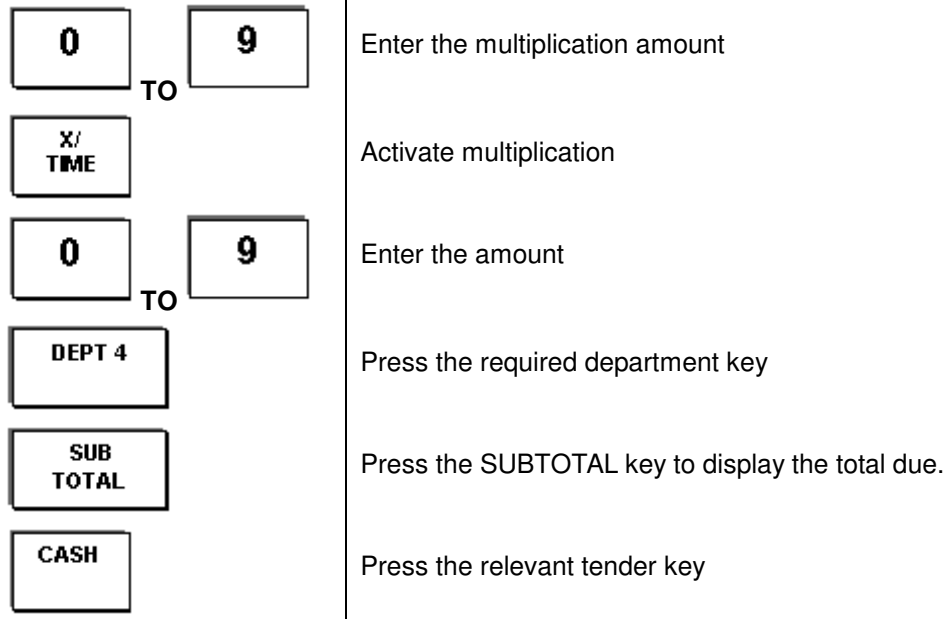

Example printout

.04	26-03-2001		Date
	13-35 0011		Time, Receipt no.
	6	X	Multiplication factor
	1.00	@	Single item price
	6.00*		Dept. 04 including tax 1
	0.48TX1		Amount of tax 1 included
	6.00	TA	Amount taxed
	6.48ST		Subtotal of registration
	6.48CA		Cash payment

* The printing of TAX information is optional. (see programming options)

■ CHANGE COMPUTATION

The amount paid by the customer can be entered using the numeric keys. The change is then calculated and displayed.

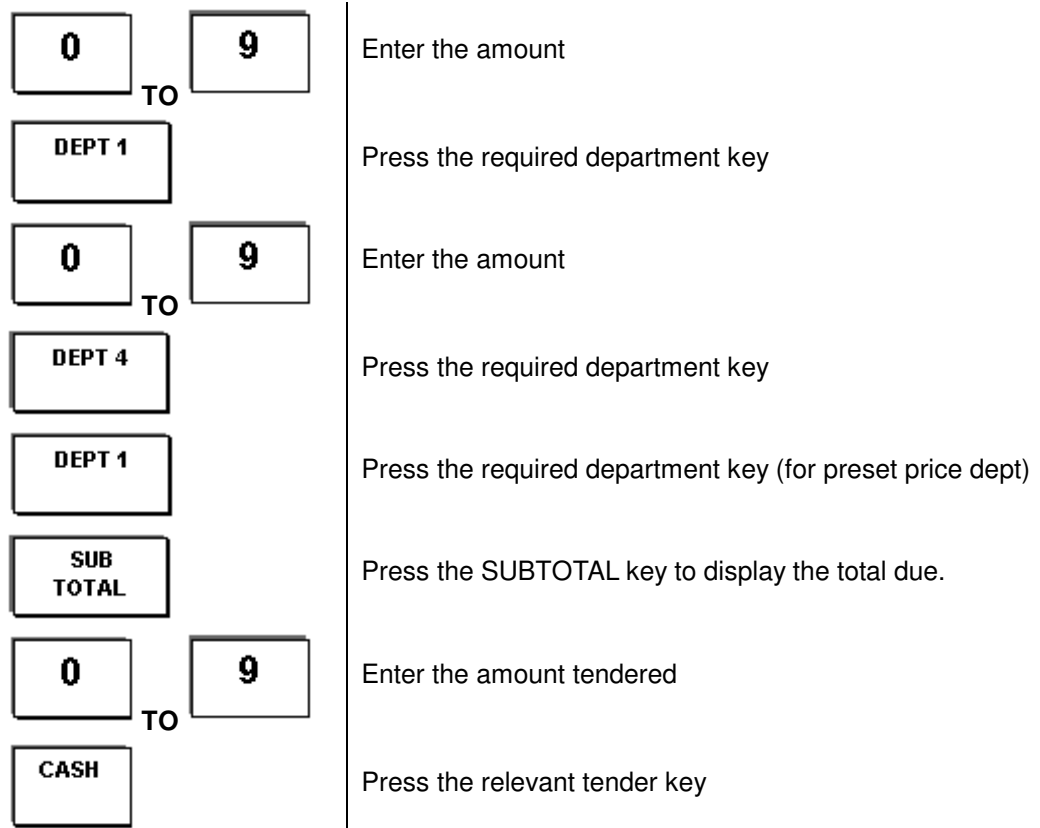

Example printout

	29-03-2001	Date
	12-54 0006	Time, Receipt no.
.01	6.50*	Dept. 01 registered amount, including tax
.04	12.00*	Dept. 04 registered amount, including tax
.01	20.00*	Dept. 01 registered amount, including tax
	3.66 TX1	Amount of tax 1 included
	22.84 TA	Amount taxed
	1.66 TX2	Amount of tax 2 included
	10.84 TA	Amount taxed
	38.50 ST	Subtotal of registration
	50.00 CA	Amount tendered (Cash Tender key)
	-11.50 CG	Change due

* The printing of TAX information is optional. (see programming options)

■ REGISTRATION OF DIFFERENT PAYMENT TYPES

It is possible to receive payment by means of Cheque, Credit-card or Cash.

0	TO	9
---	----	---

Enter the amount

DEPT 1

Press the required department key

0	TO	9
---	----	---

Enter the amount

DEPT 4

Press the required department key

SUB TOTAL

Press the SUBTOTAL key to display the total due.

0	TO	9
---	----	---

Enter the amount tendered.

Note: if the amount tendered is greater than the amount due, change will be subtracted from cash in drawer

CHEQ

Press the relevant tender key

■ SPLIT (PARTIAL) PAYMENT

A sum for payment can be paid for in several part payments. It is possible to use different types of payment for each part.

Note:

Split payments can be made using cheques, credit-cards and cash. Payments made using a check or credit-card are identified on receipts, journals and reports by "CK" or "CH" The monies tendered to each are reported and any over tender amount is reduced from the cash in drawer figure as it is assumed monies are given back to the customer

Example:

A customer wishes to split a total sales sum of £1540.50 into two part payments of £1000.00 (credit-card) and £600.00 (cash).

SUB
TOTAL

1	0	0	0	0	0
---	---	---	---	---	---

CARD

6	0	0	0	0
---	---	---	---	---

CASH

Press subtotal

Enter the part of the sum to be paid by credit card

Press the relevant tender key

Enter the amount to be paid

The amount is deducted from the remaining sum, the change due is displayed.

Example printout

	29-03-2001	Date
	13-05 0010	Time, Receipt no.
01	1540.50	
	1540.50ST	Subtotal of registration
	1000.00 CH	Part payment, credit-card
	600.00CA	Part payment, cash
	-59.50CG	Change due

* The printing of TAX information is optional. (see programming options)

Premium and discount

During registration, premium and discount operations can be performed for an item and/or subtotal according to programmed or manual percentage rates, also variable amounts can be deducted.

■ PREMIUMS - AS A PERCENTAGE

If a surcharge needs to be added, e.g. at five percent, it can be registered using the Premium key.

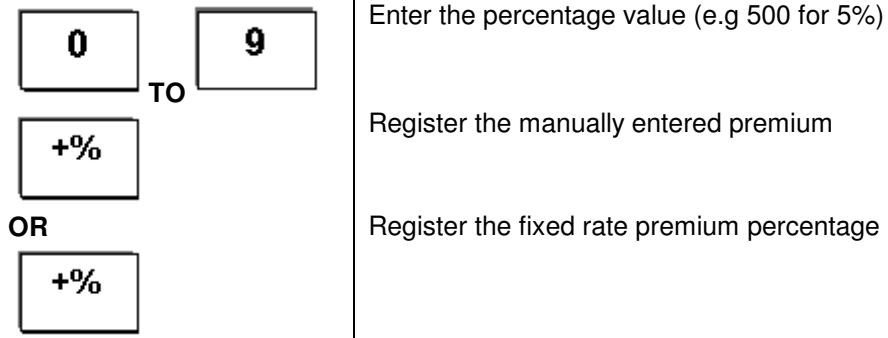

Example printout	29-03-2001 13-14 0012 .01 100.00* .01 50.00* 150.00ST 5.00 %+ 7.50 20.69TX 1 129.31 TA 157.50ST 157.50CA	Date Time, Receipt no. Registered amount, including tax Registered amount, including tax Subtotal Percentage Amount of premium, tax free Amount of tax 1 included Amount taxed Subtotal of registration Cash payment
-------------------------	--	--

* The printing of TAX information is optional. (see programming options)

■ DISCOUNTS - AS A PERCENTAGE

If a discount needs to be deducted, it can be registered using the Discount key.

0	TO	9	Enter the percentage value (e.g 500 for 5%)
-%			Register the manually entered discount
OR			
-%			Register the fixed rate discount percentage

Example printout	14-04-2001 09-48 0024 .01 100.00* .01 50.00* 150.00ST 3.00 %- -4.50 20.69TX 1 129.31 TA 145.50ST 145.50CA	Date Time, Receipt no. Registered amount, including tax Registered amount, including tax Subtotal Percentage Amount of premium, tax free Amount of tax 1 included Amount taxed Subtotal of registration Cash payment
-------------------------	---	--

■ DISCOUNTS - MANUALLY ENTERED AMOUNTS

Manually entered amounts can be subtracted from totals by using the minus key.

0	TO	9	Enter the discount amount
-			Register the discount

Example printout	29-03-2001 13-29 0015 .01 6.00* .01 7.00* .01 8.00* -10.00 - 2.90TX 1 18.10 TA 11.00ST 11.00CA	Date Time, Receipt no. Registered amount, including tax Registered amount, including tax Registered amount, including tax Amount of discount, tax free Amount of tax 1 included Amount taxed Subtotal of registration Cash payment
-------------------------	---	---

Corrections

■ ERR CORRECT

The last item entered can be deleted from the sale by pressing the ERR CORR key immediately after the item. Allowing you then to continue with the sale as normal.

0 TO **9**

Enter the amount

DEPT 1

Press the required department key

**ERR
CORR**

Press the ERR CORR key to remove the last item

OR

DEPT 1

Press the required department key

**ERR
CORR**

Press the ERR CORR key to remove the last item

■ VOID (DESIGNATED CANCELLATION)

The void key is used within the sale to remove any item that was incorrectly sold.

VOID

Void function is activated

0 TO **9**

Enter the amount

DEPT 1

The amount is cancelled from the respective department

OR

VOID

Void function is activated

DEPT 1

The amount is cancelled from the respective department

■ REFUND/RETURNED MERCHANDISE

The Refund key can be used at any time, either within the current sale or to return an item previously sold.

RF	
0	TO 9
DEPT 1	
CASH	
OR	
RF	
DEPT 1	
CASH	

Refund function is activated

Enter the amount

The amount is cancelled from the respective department

Entered amount is deducted from the department

Void function is activated

The amount is cancelled from the respective department

If the total is a negative this is subtracted from the financial reporting totals

Payments Received on Account / Paid Out

During registration, it is possible to add or subtract monies to/from the final reporting total, for values which are not normally part of a sale.

■ RECEIVED ON ACCOUNT

This records monies placed in the cash drawer which were not for sales made

0	TO	9
RA/ CALC		

Enter the amount to be received on account (i.e. deposit or float)

Amount is registered and the cash drawer opens

Example printout

08-05-2001
10-10 0006
100.00 RA

Date
Time, Receipt no.
Received amount, cash

■ PAID OUT

This removes money from the financial totals for payments out of the cash drawer

0	TO	9
PO		

Enter the amount to be paid out (removed from cash drawer)

Amount is registered and the cash drawer opens

Example printout

08-05-2001
10-50 0009
-60.00 PO

Date
Time, Receipt no.
Amount paid out

Miscellaneous Register Operations

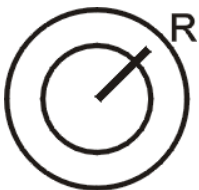

Set the key to position R

■ RECEIPT DUPLICATION

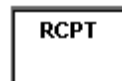

The last receipt can be duplicated by using the

The after sales receipt has the capabilities of printing a maximum of 45 lines

Example printout 10-02-2001 08-09 0010 .02 300.00 300.00 ST 300.00 CA	Start of duplicated receipt Date Time, Receipt no. Registered amount Subtotal of registration Cash payment End of duplicated receipt
-------------------------	--	--

■ OPEN CASH REGISTER ELECTRONICALLY

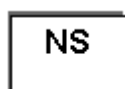

Open cash drawer

Example printout	10-10 0007 NS	Time, Receipt no. Drawer opens (No Sale)
-------------------------	-----------------------	---

■ OPEN CASH DRAWER MANUALLY

The cash drawer can be opened manually, e.g. following a power failure.
 - Press the lever on the underside of the cash drawer towards the printer mechanism.

■ TIME DISPLAY

The cash register is equipped with an internal clock. The time and date are printed on each receipt. The time or date can be shown in the display.

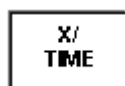

Time is displayed

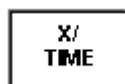

Date is displayed

Note The CLEAR key will remove the DATE/TIME from the display.

Calculator Operation

The Cash Register has the ability to act as a normal calculator. Unlike making a sale, during this operation no information is added to the reporting totalisers.

■ ADDITION

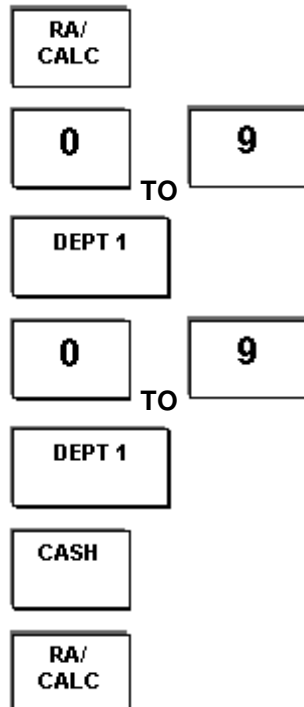

Start the calculator operation. An arrow is shown on the display above the word "CALC"

Enter the value (assuming 2 decimals i.e. 500 for 5)

Press **DEPT 1** for the plus calculation button.

Enter the value (assuming 2 decimals i.e. 500 for 5)

Press **DEPT 1** for the plus calculation button.

Get the total, end the calculator operation

The arrow disappears.

■ SUBTRACTION

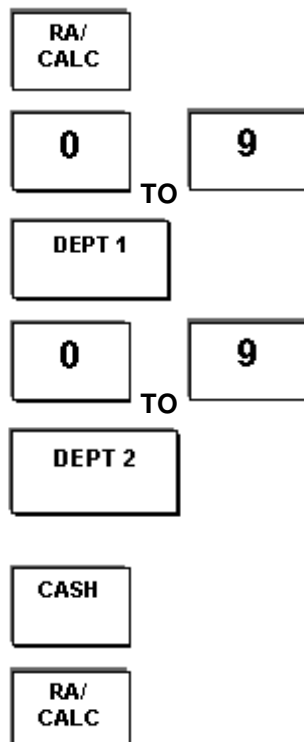

Start the calculator operation. An arrow is shown on the display above the word "CALC"

Enter the value (assuming 2 decimals i.e. 500 for 5)

Press **DEPT 1** for the plus calculation button.

Enter the value (assuming 2 decimals i.e. 500 for 5)

Press **DEPT 2** for the minus calculation button.

Get the total, end the calculator operation

The arrow disappears.

■ MULTIPLICATION

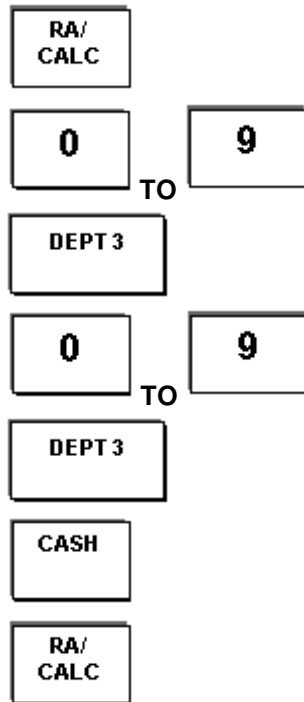

Start the calculator operation. An arrow is shown on the display above the word "CALC"

Enter the value (assuming 2 decimals i.e. 500 for 5)

Press **DEPT 3** for the multiplication calculation button.

Enter the value (assuming 2 decimals i.e. 500 for 5)

Press **DEPT 3** for the multiplication calculation button.

Get the total, end the calculator operation

The arrow disappears.

■ DIVISION

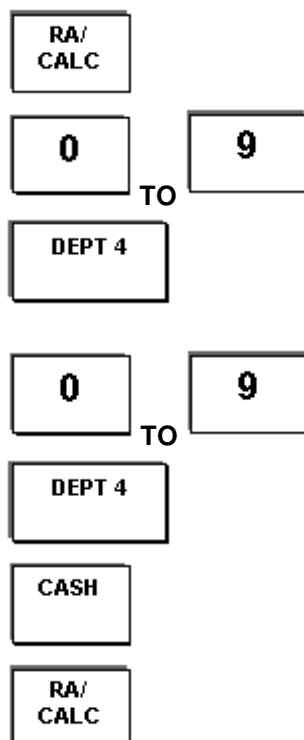

Start the calculator operation. An arrow is shown on the display above the word "CALC"

Enter the value (assuming 2 decimals i.e. 500 for 5)

Press **DEPT 4** for the division calculation.

Enter the value (assuming 2 decimals i.e. 500 for 5)

Press **DEPT 4** for the division calculation.

Get the total, end the calculator operation

The arrow disappears.

REPORTS

The cash register stores all transactions in various records, enabling subsequent analysis of the registrations according to different aspects.

It is possible to generate and print reports without deleting the memory content. These reports are generated with the key in position **X**. It is also possible to generate reports whose content is deleted from the memory when the report is completed and has been printed. These reports are generated with the key in position **Z**.

■ PASSWORD

A password can be assigned to protect the X-report and Z-report from unauthorized manipulation. The password is a four-digit code (defined by the program position) which does not appear in the display when entered. The entry must be concluded by pressing

SUB TOTAL

Note: Print out of a report can be stopped at any time by pressing

CLEAR

■ X-REPORTS (WITHOUT MEMORY DELETION)

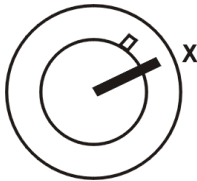

The following reports can be generated with the key in

- Financial report
- Full X-report

Example printout

X/ TIME	Financial report is printed
07-05-2001	Date
19-25 0050	Time, Receipt no.
X	
44	Number of items registered
3557.91*	Total
24	Number of receipts (number of customers)
3443.47NT	Net sales
1947.99CA#	Total of cash registrations
1805.50 CK	Total of cheque registrations

■ Z-REPORTS (WITH MEMORY DELETION)

The following reports can be generated with the key in position Z (the example printouts correspond to those of the X-reports except that a Z appears

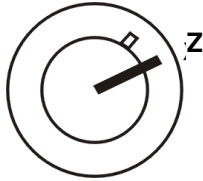

Financial Report

The following reports can be generated with the key in

- Full Z-report

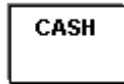

Full Z Report is printed out and then deleted. The Grand Total (sum of all the registered amounts) is not deleted.

■ ABBREVIATIONS

Reports

X	Full report without memory deletion
Z	Full report with memory deletion
-	Total of discounts
%-	Discount percentage
%+	Premium percentage
TX1-4	Total tax according to tax rates 1-4
TA	Amount taxed
TX	Tax total
NT	Net sales Total cash sales
CA	Total cash sales
CH	Total credit-card sales
RA	Total amount received in cash
PO	Total paid out, cash
VD	Total of voids
RF	Total of refunds
NS	No sale drawer opening
CA#	Total sum in cash register
CK	Total cheque sum in cash register
AT1-4	Currencies total 1-4
#	Grand Total

Registration

CA	Cash
CH	Payment by credit card
CK	Payment by cheque
RA	Payment received on account
PO	Paid out
NT	Net total
ST	Subtotal
AT1-4	Amount is specified currency
CG	Change
TX1-4	Tax contained according to tax rates
TA	Amount taxed
RF	Total of refunds
%+	Premium percentage
%-	Discount percentage
-	Discount, variable amount
VD	Void correct
NS	No sale drawer opened
@	Item price
*	Tax calculated
X	Multiplication
€	Amount in Euro

■ SAMPLE REPORT

Example printout

	09-04-2001		Date
	20-15 0050		Time, Receipt no.
		X	X-report
.01	4		Number of registrations, department 01
	6.73		Sales, department 01
.02	4		Number of registrations, department 02
	14.00		Sales, department 02
.03	2		Number of registrations, department 03
	6.60		Sales, department 03
	10		Number of registrations, all department
	27.33		Sales, all department
	0.00	-	Amount of variable discounts
	0.33	%+	Amount of premium percentage
	0.35	%-	Amount of discount percentage
	1.08	TX1	Total of tax 1
	6.73	TA	Amount taxed at tax rate 1
	2.11	TX2	Total of tax 1
	14.00	TA	Amount taxed at tax rate 2
	0.92	TX3	Total of tax 3
	6.60	TA	Amount taxed at tax rate 3
	0.00	TX4	Total of tax 4
	0.00	TA	Amount taxed at tax rate 4
	4.11	TX	Total taxed
	5		Number of receipts (number of customers)
	31.42	NT	Total sales
	3		Number of cash payments
	12.25	CA	Cash in drawer
	1		Number of credit-card payments
	1.00	CH	Total of credit-card payments
	1		Number of cheque payments
	4.00	CK	Total of cheque payments
	100.00	RA	Total of received on account
	200.00	PO	Total paid out
	1	VD	Number of error correction/ Void
	1		Number of refund registrations
	2.90	RF	Total of refunds
	3	NS	Number of no sale drawer openings
	-87.75	CA#	Total of cash payments in cash register
	1.00	CH	Total of credit-card payments in cash register
	4.00	CK	Total of cheque payments in cash register
1	1		Number of transactions, exchange rate 1
	5.47	AT1	Total, exchange rate 1
2	1		Number of transactions, exchange rate 2
	5.47	AT2	Total, exchange rate 2
3	1		Number of transactions, exchange rate 3
	5.47	AT3	Total, exchange rate 3
4	1		Number of transactions, exchange rate 4
	5.47	AT4	Total, exchange rate 4

Programming

The CR101 cash register can be programmed and thus adapted to meet individual requirements. Programming is divided into various areas.

- The Basic program (Flags) is used to define general setting, such as date format, type of tax calculation, etc.
- The Department program is used to allocate prices and assignments to departments.
- The Tax Rate program can be used to enter four different tax rates.
- The Currency Conversion program is used to enter currency rates.

■ GENERAL INFORMATION

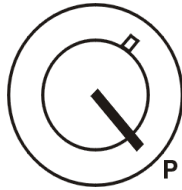

P Set the key to the P position

RESTORE FACTORY DEFAULTS

Caution:-

After pressing the following key combination, all programmed values are deleted and the machine reset to its "Default State".

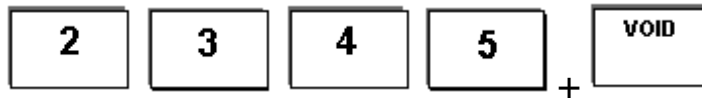

All program values are reset

REMOVE RUNNING TOTALS

Caution:-

After pressing the following key combination, the grand total is deleted. It can only be performed when the Z-reports have been printed out beforehand.

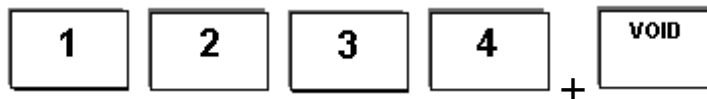

Note:

During programming (key position: P), all input can be corrected by pressing the

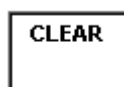

before storing it by pressing the

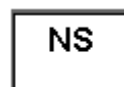

key

■ PRINTING ALL PROGRAMMED SETTINGS (FLAGS)

It is possible to print out all the settings currently programmed by carrying out the following steps.



Set the key to position P

Print basic program settings

RA/
CALC

CHEQ

The basic settings are printed out

Print Tax settings

PO

CHEQ

The Tax settings are printed out

Print department settings

DEPT 1

CHEQ

The department settings are printed out

Print currency conversion

€
EURO

CHEQ

The currency conversion program data is printed out

■ PROGRAMMING THE BASIC PROGRAM

In order to set the individual flags, carry out the steps described below.



Set the key to position P

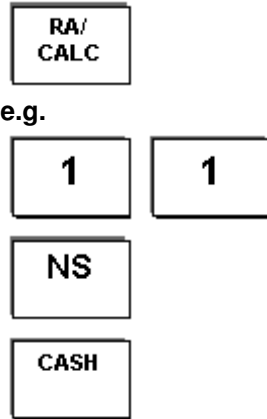

The basic program is activated

“01” appears on the left side of the display for flag 01
Enter the required value

Store the settings and move to the next flag.
“02” appears in the display, indicating Flag 02
Program the other flags in the same way
Conclude programming and exit the programming mode.

■ MODIFYING A SINGLE FLAG

Each flag can be selected directly, e.g. Date.

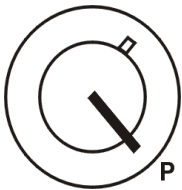

Set the key to position P

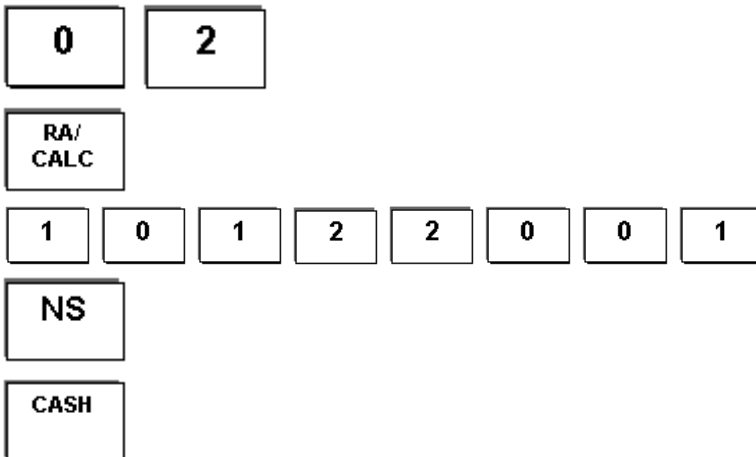

Enter the flag number for setting the date

Open the basic program for date and time

Enter the date.

Store the settings

Conclude programming and exit the programming mode.

■ FLAG TABLE

FLAG 01

Date format + Journal/Receipt printout

1	1	= Recommended setting
0		= Month-Day-Year (MM-DD-YYYY)
1		= Day-Month-Year (DD-MM-YYYY)
2		= Year-Month-Day (YYYY-MM-DD)
	0	= Journal printout
	1	= Receipt printout

FLAG 02

Date

2	8	0	2	2	0	0	0	= Example for 28 February 2000
								= (DD-MM-YYYY)

FLAG 03

Time

1	4	3	0	= Example for 2:30 p.m. (hour:minute)
---	---	---	---	---------------------------------------

FLAG 04

Tax rounding

0	1	= Recommended setting
0		= Commercial rounding 5/4 (1.114=1.11) (1.115=1.12)
1		= Absolute rounding up (1.111 = 1.12)
2		= Absolute rounding off (1.119 = 1.11)
	0	= Net price (excluding tax)
	1	= Gross price (including tax)

→ This bit can be modified after Z Report printed and Grand Total cleared.

FLAG 05

Rounding, premium/discount

0	0	= Recommended setting
0		= Commercial rounding 5/4 (premium)
1		= Absolute rounding up (premium)
2		= Absolute rounding off (premium)
	0	= Commercial rounding 5/4 (discount)
	1	= Absolute rounding up (discount)
	2	= Absolute rounding off (discount)

FLAG 06

Tax, premium/discount

1	1	= Recommended setting
0		= Premium tax free
1		= Premium taxable
	0	= Discount tax free
	1	= Discount taxable

FLAG 07

Fixed premium percentage

1	0	5	0	= Example for 10.5% (surcharge); always enter a 4-digit number without decimal point
---	---	---	---	--

FLAG 08

Fixed discount percentage

0	3	5	0	= Example for 3.5% (discount); always enter a 4-digit number without decimal point
---	---	---	---	--

FLAG 09

Foreign currency exchange (FCE) rounding

0	1	= Recommended setting
0		= Commercial rounding 5/4
1		= Absolute rounding up
2		= Absolute rounding off
	0	= Do not print Foreign currency rate
	1	= Print Foreign currency rate

FLAG 10

Printer off/on + decimal places + self test

1	2	1	= Recommended setting
0			= No receipt, reports and programming possible
1			= Receipt, reports and programming possible
	0		= No decimal places
	1		= One decimal places (0.0)
	2		= Two decimal places (0.00)
	3		= Three decimal places (0.000)
		0	= No self test
		1	= Self test

FLAG 11

Tax calculation + Header layout

0	0	= Recommended setting
0		= Gross amount, tax total, net amount
1		= Gross amount, tax total, no net amount
2		= Gross amount, no tax total, net amount
3		= Gross amount, no tax total, no net amount
	0	= Date, time, consec. receipt number
	1	= Date, no time, consec. receipt number
	2	= Date, time, no consec. receipt number
	3	= Date, no time, no consec. receipt number

FLAG 12

Tax, premium/discount

0	0	= Recommended setting
0		= Full receipt/journal printout
1		= Abbreviated receipt/journal printout
	0	= Multiple printing of subtotal not possible
	1	= Multiple printing of subtotal possible

FLAG 13

Z-report layout

1	0	= Recommended setting
0		= Grand Total is not printed, receipt no. reset
		= Grand Total is printed, receipt no. reset
2		= Grand Total is not printed, receipt no. not reset
3		= Grand Total is printed, receipt no. not reset
	0	= Refund total in X/Z report is printed
	1	= Refund total in X/Z report is not printed

FLAG 14

Paper winding motor on/off + Tax rate minus key

1	0	0	0	0	= Recommended setting
0					= Paper winding motor off
1					= Paper winding motor on
	0				= Minus key tax free
	1				= Minus key with tax rate 4
		0			= Minus key tax free
		1			= Minus key with tax rate 3
			0		= Minus key tax free
			1		= Minus key with tax rate 2
				0	= Minus key tax free
				1	= Minus key with tax rate 1

FLAG 15

Euro representation

0	0	= Recommended setting
0		= Euro course is not printed
1		= Euro course is printed
	0	= Not define
	1	= Not define

FLAG 16

Open cash register drawer + Zero skip

0	1	= Recommended setting
0		= Opening drawer is permitted
1		= Opening drawer is not permitted
	0	= Zero skip permitted in report
	1	= Zero skip not permitted in report

FLAG 17

Password of X-report and Z-report

0	0	0	0	= No password / Password 0001 to 9999
---	---	---	---	---------------------------------------



PROGRAMMING TAX

Programming tax rates

Departments can be assigned four different tax rates.
 This program is used to define the level of the tax rate.

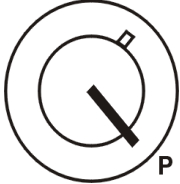

Activate Programming mode

Shown on display	Operation	Description
RATE 1 00000	PO	Open the Tax rate programming
RATE 1 16000	0 to 9	Enter the tax rate (e.g 16000 equals 16%)
	NS	Store the rate and move the next tax rate.
	CASH	Conclude programming and exit programming mode.

■ PROGRAMMING DEPARTMENTS

Programming is performed in two steps; the price and the assignment must be specified.



Activate Programming mode

Define the price

Shown on display

01P 0.00

00P 0.00

00999P 999

Operation

DEPT 1

0 to 9

NS

CASH

Description

Select department

Enter the price

Store the rate and move the next tax rate.

Conclude programming and exit programming mode. **Note:** To continue with setting department status do not press **cash**

■ DEFINE THE ASSIGNMENT

Shown on display

01F 00000

01F 00000

01F 00000

01F 00001

01F 00010

01F 00100

01F 01000

Indicates the department

Indicates the assignment mode

0=Price is added (1=single receipt following initial input)

0 = No tax (1= tax rate 1)

0 = No tax (1 = tax rate 2)

0 = no tax (1 = tax rate 3)

0 = no tax (1 = tax rate 4)

NS

CASH

An example for department 1 (e.g. household goods) is provided below.

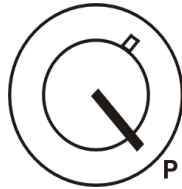

Set the key position to P

	DEPT 1	Open the department programming
	12.99	Enter the fixed price
01P 1299	NS	Store the price
	00001	Enter the assignment
	NS	Store the assignment
01P 00001	CASH	Close the department program

■ PROGRAMMING BEFORE EURO CURRENCY CONVERSION

Programming the Currency conversion rates BEFORE the change to Euro.

Up to four different currencies and their conversion factors can be programmed in order to convert or total the sum of a transaction. Before the change over to Euro currency it is necessary to program the cash register to calculate the currency exchanges through the Euro exchange rate. The Euro exchange rate **MUST** be programmed to **Currency Exchange 3**. The rate that you enter is the number of Euro's to the currency. If you require the euro to print on the customer receipt please refer to program flag 15

Note: The conversion factors for the currencies must be entered as six-digit values.

Local currency = Pound Sterling.
The currencies (FCE keys) must be programmed as follows:

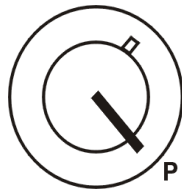

P Set the key position to P

FCE1	0	<div style="border: 1px solid black; padding: 2px; width: fit-content; margin: 0 auto;">€ EURO</div> <p><i>(Use the keypad to enter rate.)</i></p> <div style="display: flex; justify-content: space-around; align-items: center;"> <div style="border: 1px solid black; padding: 5px; width: 40px; text-align: center;">0</div> to <div style="border: 1px solid black; padding: 5px; width: 40px; text-align: center;">9</div> </div> <div style="border: 1px solid black; padding: 5px; width: fit-content; margin: 10px auto; text-align: center;">NS</div>	<p>Open the currency conversion program</p> <p>Enter the current conversion rate for conversion 1 using the 0 to 9 keys. (if required) Eg 791234 for Punts to Euro's</p> <p>Move to the next setting</p>
Dot1	26	<div style="border: 1px solid black; padding: 5px; width: 40px; text-align: center;">2</div> <div style="border: 1px solid black; padding: 5px; width: 40px; text-align: center;">6</div>	<p>0 = compulsory 6 = The number of decimal places used by the conversion</p>
FCE2	0	<p><i>(Use the keypad to enter rate.)</i></p> <div style="display: flex; justify-content: space-around; align-items: center;"> <div style="border: 1px solid black; padding: 5px; width: 40px; text-align: center;">0</div> to <div style="border: 1px solid black; padding: 5px; width: 40px; text-align: center;">9</div> </div> <div style="border: 1px solid black; padding: 5px; width: fit-content; margin: 10px auto; text-align: center;">NS</div>	<p>Move to next setting</p> <p>Enter the current conversion rate for conversion 2 using the 0 to 9 keys. (if required) Eg 791234 for DM to Euro's</p> <p>Move to next setting</p>
Dot2	26	<div style="border: 1px solid black; padding: 5px; width: 40px; text-align: center;">2</div> <div style="border: 1px solid black; padding: 5px; width: 40px; text-align: center;">6</div>	<p>0 = compulsory 6 = The number of decimal places used by the conversion</p>

FCE3 0

Note. If you are using receipts showing both EUROS and home currency totals, this rate is required.

Dot3 06

FCE4 0

Dot4 26

NS

(Use the keypad to enter rate.)

0 to 9

Move to next setting

Enter the current conversion rate using the 0 to 9 keys. For your Home currency to EURO's
E.g. 0791234 for Punt's to Euro's

NS

0 6

Move to next setting

0 = compulsory 6 = The number of decimal places used by the conversion

NS

Move to next setting

(Use the numeric keypad to enter rate.)

0 to 9

Enter the current conversion rate for conversion 4 using the 0 to 9 keys. (if required)
E.g. 791234 for Francs to Euro's

NS

Move to next setting

2 6

0 = compulsory 6 = The number of decimal places used by the conversion

NS

Move to next setting

CASH

Close the currency conversion program





■ PROGRAMMING AFTER EURO CURRENCY CONVERSION

Programming the Currency conversion rates AFTER the change to Euro.

Local currency = Euros
 The currencies (FCE keys) must be programmed as follows:

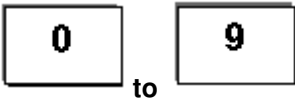
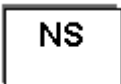

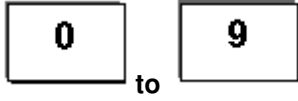
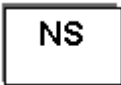
P Set the key to position P

FCE1 0	<div style="text-align: center;">  (Use the keypad to enter rate.)  </div>	Open the currency conversion program Enter the current conversion rate for conversion 1 using the 0 to 9 keys. (if required) Eg 791234 for Punt's to Euro's
Dot1 16	<div style="text-align: center;">   </div>	Move to the next setting 0 = compulsory 6 = The number of decimal places used by the conversion
FCE2 0	<div style="text-align: center;"> (Use the keypad to enter rate.)   </div>	Enter the current conversion rate for conversion 2 using the 0 to 9 keys. (if required) Eg 791234 for DM to Euro's
Dot2 16	<div style="text-align: center;">  </div>	Move to next setting 0 = compulsory 6 = The number of decimal places used by the conversion

FCE3 0

NS

(Use the keypad to enter rate.)

0 to 9

Move to next setting

Enter the current conversion rate using the 0 to 9 keys. For your Home currency to EURO's
E.g. 0791234 for Punts to Euro's

Dot3 16

NS

1 6

Move to next setting

0 = compulsory 6 = The number of decimal places used by the conversion

FCE4 0

NS

(Use the numeric keypad to enter rate.)

0 to 9

Move to next setting

Enter the current conversion rate for conversion 4 using the 0 to 9 keys. (if required)
E.g. 791234 for Francs to Euro's

Dot4 16

NS

1 6

Move to next setting

0 = compulsory 6 = The number of decimal places used by the conversion

NS

Move to next setting

CASH

Close the currency conversion program









■ PROGRAMMING NON EURO CURRENCY CONVERSION

Programming the Currency conversion rates for Non Euro Countries

The currencies (FCE keys) must be programmed as follows:



SET THE KEY TO POSITION P

FCE1	0		Open the currency conversion program
		<i>(Use the keypad to enter rate.)</i>	Enter the current conversion rate for conversion 1 using the 0 to 9 keys. (if required) Eg 791234 for Puntos to Euro's
			
			Move to the next setting
Dot1	16		
			0 = compulsory 6 = The number of decimal places used by the conversion
			Move to next setting
FCE2	0		
		<i>(Use the keypad to enter rate.)</i>	Enter the current conversion rate for conversion 2 using the 0 to 9 keys. (if required) Eg 791234 for DM to Euro's
			
			Move to next setting
Dot2	16		
			0 = compulsory 6 = The number of decimal places used by the conversion

FCE3 0

NS

(Use the keypad to enter rate.)

0 to 9

Move to next setting

Enter the current conversion rate using the 0 to 9 keys. For your Home currency to EURO's
E.g. 0791234 for Punts to Euro's

Dot3 16

NS

1 6

Move to next setting

0 = compulsory 6 = The number of decimal places used by the conversion

FCE4 0

NS

(Use the numeric keypad to enter rate.)

0 to 9

Move to next setting

Enter the current conversion rate for conversion 4 using the 0 to 9 keys. (if required)
E.g. 791234 for Francs to Euro's

Dot4 16

NS

1 6

Move to next setting

0 = compulsory 6 = The number of decimal places used by the conversion

NS

Move to next setting

CASH

Close the currency conversion program

Error messages

Error messages operation

Error messages appear in the display, and an acoustic signal is issued, as a result of incorrect operation.

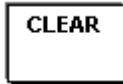

Press  and the error message is cleared, then correctly complete the desired operation

Printer malfunction

In the case of a printer error, switch the cash register off immediately and unplug the power connector.

Check that the paper rolls are installed correctly. Whether the paper or ink roller are damaged or objects have fallen into the printer mechanism. Remove them if they have

Caution: remove any objects extremely carefully. Do not use knives, screwdrivers or similar tools to help. Never apply force. This may damage the printer

Then switch the register on again and carry out a complete registration. If the printer fault occurs again contact your service center.

Options and Maintenance

Options

Keypad cover (not included). The cash register keypad can be protected from moisture and dust by means of a keypad cover.

Self Tests

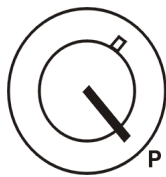





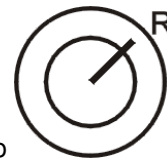
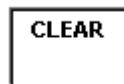

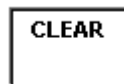
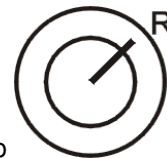

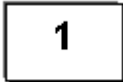
P SET THE KEY TO POSITION P

It is possible to enable the execution of self-tests (Flag 10). The self-tests check individual cash register components.

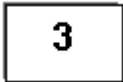

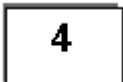
It is possible to leave the self test mode by pressing  or by returning to 

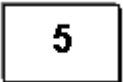
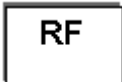
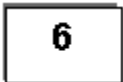
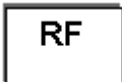
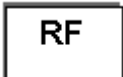
		Tests the display
		Tests the printer
		Tests the acoustic alarm signal
		Tests the cash drawer
		Tests the keypad
		Tests the key-operated switch
		Complete test (1-6)

■ SPECIFICATIONS

Keys	34
Departments:	4
Display:	10-digit display
Printer:	Speed: Approx. 2 lines/sec. Paper roll: 57 mm wide, Ø 70 mm Ink roller: Blue
Noise level:	LpA < 58dB
Dimensions and weight:	Height: 200 mm Width: 330 mm Depth: 360 mm Weight: Approx. 5 kg
Safety tests:	Complying with EN 60 950, (IEC 950) CE.
Power consumption:	Operation: 10 W
Power supply:	240 V, 50 Hz

